

# TYPE PSI/II MANUAL LIVE-FRONT PAD-MOUNTED SWITCHGEAR 15kV • 25kV



*The PSI/II Pad-Mounted Switchgear is Federal Pacific's line of live-front pad-mounted switchgear (available as UL® Listed) built to IEEE C37.74 requirements and features the fully tested and field proven Auto-jet® load-interrupter switch for switching three-phase circuits and the integral load-interrupter for single-phase load-break operation with fuses.*

## General

- 15kV and 25kV Class - both available as UL® Listed
- Proven Auto-jet® switching
- Ratings normally found only in metal-enclosed switchgear
- Meets IEEE C37.74 requirements including 3-time fault-closing on switches and fuse mountings
- Removable barriers using NEMA Class GPO-3 non-hygroscopic fiberglass reinforced polyester barriers
- 100% X-rayed cycloaliphatic epoxy insulators
- 11-gauge pickled-and-oiled steel, all welded construction
- Meets ANSI C57.12.28 cabinet security and enclosure finish requirements
- Stainless-steel door-handle covers and switch operating pockets
- Stainless-steel hinges and hinge pins
- Overlapping active-passive door system with 3-point auto-latch door mechanism, padlockable door handle and standard penta-head or optional hex-head security bolts

- Ventilation louvers not required, sufficient ventilation being attained through non-gasketed doors and roof
- Anti-condensation roof undercoating
- Positive Latch Indicator on fuse interrupters verifies fully latched condition

PSI/II Pad-Mounted Switchgear is designed to meet the switching and isolating requirements of electrical distribution systems with 15 pre-engineered switching configurations. There are UL® Listed standard units available to cover almost every situation — radial feed, loop feed and manual primary-selector switching. Special configurations and designs are available upon request. The three-time fault-close ratings, with the laboratory and field-proven Auto-jet® system, can solve both your "near substation" high fault-current and mid-point loop switching applications as well as "distant end-point" standard fault-current requirements.

## Applications

PSI/II Pad-Mounted Switchgear lends itself to meet distribution system requirements, whether it is a simple radial feed or a complex loop system. With 3-pole, group-operated load-interrupter switches, 3-phase sets of single-pole fuses and solid bus taps all available as UL® Listed — applications are almost unlimited.

### Radial Feed ⇒

PSI/II Pad-Mounted Switchgear provides isolation and fuse protection in radial systems. Radial systems are used where service reliability and load type do not warrant the increased investment of the more flexible loop system. The radial system is used where there are many lateral cables, each to serve a small number of dispersed loads.

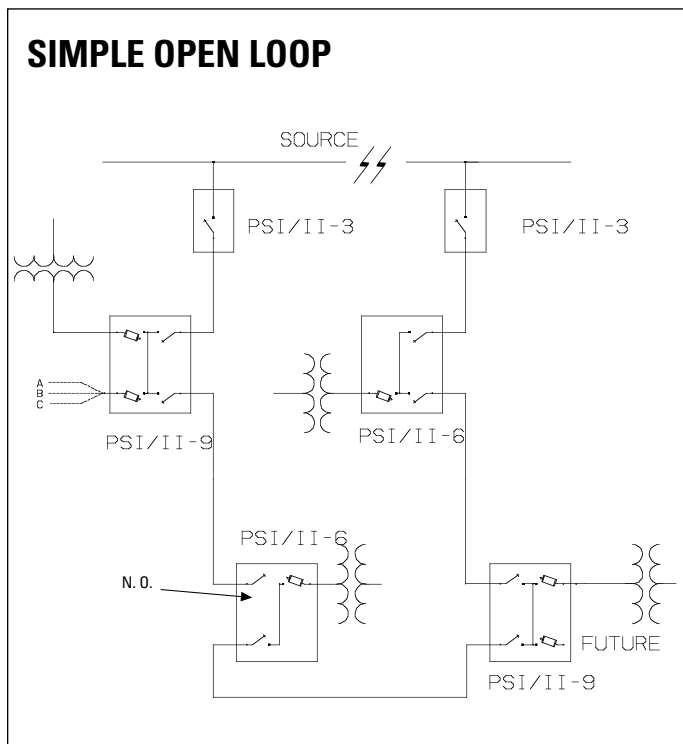
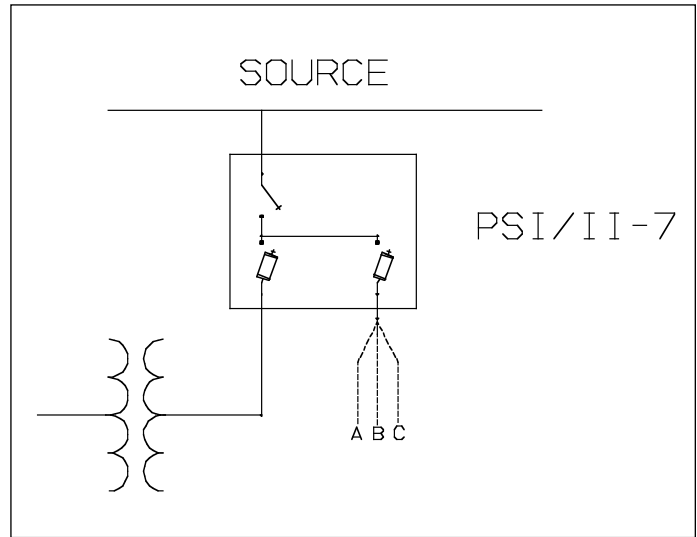

### Primary Selector Switch ⇒

PSI/II Pad-Mounted Switchgear units are applied as primary selector switches to serve critical loads. This allows manual restoration of service upon the loss of the preferred source.

### ← Loop Feed

PSI/II Pad-Mounted Switchgear provides sectionalizing in a loop feed distribution system. This system, with loop cable attached to the source at two points and a "normally open" switch near the load mid-point, provides excellent manual sectionalizing. The Auto-jet® II switches are opened and closed as required to isolate a cable problem or faulted circuit condition and to provide complete service restoration.

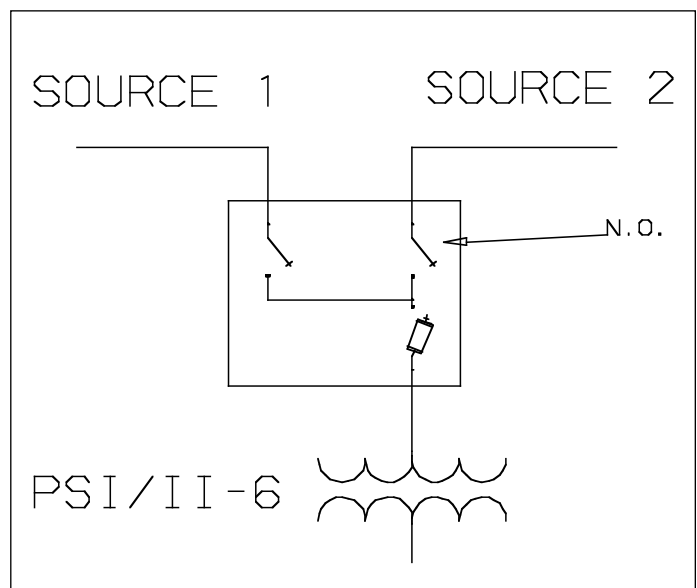

## Features

The basic switchgear enclosure has been designed to present the smallest possible profile commensurate with the generally accepted electrical clearances, operating procedures, component requirements and various methods of training and terminating underground distribution cable. These pad-mounted switchgear designs are UL® Listed.

Standard features include: heavy 11-gauge hot-rolled pickled-and-oiled steel, all welded construction, stainless-steel hinges and switch operating pockets, active/passive compartment access doors with 3-point auto-latch door mechanisms, padlockable door handles and penta-head security bolts. These standard features, along with a rugged tamper-resistant design, provide a unit that meets the stringent security requirements of ANSI C57.12.28.

Electrical integrity has been enhanced by the Auto-jet®II switching system, NEMA Class GPO-3 barriers, 100% x-rayed cycloaliphatic epoxy insulators and a wide choice of both power and current-limiting fuses. High quality steel, corrosion-resistant hardware, chemical cleaning and phosphating or zirconization, corrosion resistant epoxy-powder primer and a baked polyester-powder top-coat make the anti-corrosion coating system a leader in the industry. The standard finish color is pad-mount green, Munsell 7GY3.29/1.5.

Standard options let you select units that best serve your needs and operating practices. Options include: front barriers to meet either NESC or RUS specifications; base spacers to provide for increased cable terminating height; ground stirrups for convenient cable grounding; key interlocking for anti-paralleling and access control; and surge arresters. These are just a few of the many options listed on pages 18 and 19.

*Switch-side removable interphase barriers facilitate cable installation and termination. Interphase barriers are **not** to be removed when switchgear is energized.*



## Barriers

Designing equipment to a minimum size consistent with electrical clearance requirements adds to the aesthetic qualities of pad-mounted switchgear. The use of interphase, phase-to-ground and dual-purpose front barriers enhance operation by field personnel. The dual-purpose barriers, in their normal hanging position, help prevent inadvertent contact with live parts. In addition, these barriers can be temporarily inserted into the open gap when the switch or fuse is open, but should not remain in this alternate position for more than one week. A removable, clear window panel above the switch dual-purpose barriers allows visual verification of the switch blade position with the barriers in their normal hanging position. A fixed metal panel is mounted above the dual-purpose barriers in the fuse compartments as a top barrier guide.

Some barrier systems while highly desirable, restrict the space available for installing and terminating high-voltage cables entering the switch and fuse compartments. To eliminate this restriction, Federal Pacific's standard barrier system, in PSI/II switch and fuse compartments, incorporates unique "removable" barriers which allow removal of interphase barriers during cable installation . . . without removal of any hardware. With the switchgear completely de-energized, removal of these barriers from a compartment facilitates cable installation, termination and repair. In order to get this same freedom during installation, other barrier systems require time consuming disassembly and reassembly.



*Switch compartments (above) with dual-purpose barrier shown in normal hanging position on compartment at right and in alternate slide-in position on compartment at left. Barrier should **not** be left in alternate position for more than one week. Hinged B4 barrier shown on switch compartment at left.*



*Fuse compartments (at right) shown with dual-purpose barriers in temporary storage position on door, in alternate slide-in position on center phase of left compartment (barriers should **not** be left in alternate position for more than one week and in normal hanging position on right compartment).*

*Fuse-compartment interphase barriers are removable without loosening hardware — no tools required. Interphase barriers are **NOT** to be removed when switchgear is energized.*



*Fuse-compartment dual-purpose barriers in normal hanging position. Hinged B4 barrier also shown.*

## Auto-Jet® II Switch

The unique feature of the Federal Pacific PSI/II Pad-Mounted Switchgear is the Auto-jet®II 3-pole group-operated switch. The Auto-jet®II switch provides 600 amperes continuous and load-break at 15kV and 25kV, and to 40,000 amperes RMS/ASYM momentary and 3-time fault-close capability. Switches rated 1200 amperes continuous and interrupting are also available. The Auto-jet® II switch provides a unique method of load interruption, producing a laminated jet of air which extinguishes the arc. Auto-jet®II switches are designed to provide a safe and convenient means for 3-pole switching of distribution transformers, cable loops and laterals, and to provide manual selection of preferred and alternate sources.

All Auto-jet®II switches have a heavy-gauge steel frame which assures proper contact alignment and eliminates any problem of switch-to-enclosure alignment. A quick-make, quick-break stored energy mechanism with heavy-duty, long-life die springs, provides high speed opening and closing independent of the operating handle speed. This high speed mechanism assures safe 3-time fault-closing capability and load interruption with the Auto-jet®II interrupter. The switch blades are made of high conductivity copper. Current transfer from the switchblade through the hinge terminal is accomplished by a unique current transfer means, consisting of a silver-plated beryllium copper louvered contact band encircling a silver-plated copper heavy walled precision bushing at the hinge point. Due to higher than normal current flow, magnetic forces tend to rotate the louvers on the contact band toward a vertical position, providing a higher contact pressure for fault-current duty.

## Auto-Jet® II Switch Ratings

Nom.	kV			Amperes, RMS ①					
	Max. Des.	BIL ②	Max. Cont.	Interrupting			Mom. & Fault-Close (ASYM KA)	Fault-Close Duty-Cycle ③	1-sec. (SYM KA)
				Max. Load	Cable Chrg.	Mag.			
14.4	17	95	600	600	10	21	40	3	25
14.4	17	95	1200	1200	10	21	40±	3*	25
25	29	125	600	600	5	21	40	3	25
25	29	125	1200	1200	5	21	40	3	25

① These are nominal switch ratings. Rating of integrated pad-mounted unit is determined by lowest rated component and may be limited by fuse ratings. Use fuse rating charts on pages 15 and 17 to select proper short circuit values.

② Barriers installed.

③ The 3-time fault-close duty-cycle rating means that the device can be closed three times into rated fault-current and remain operable and able to carry and interrupt its rated load-current.

\*1-time duty-cycle fault-closing rating is 61ka rms asymmetrical.

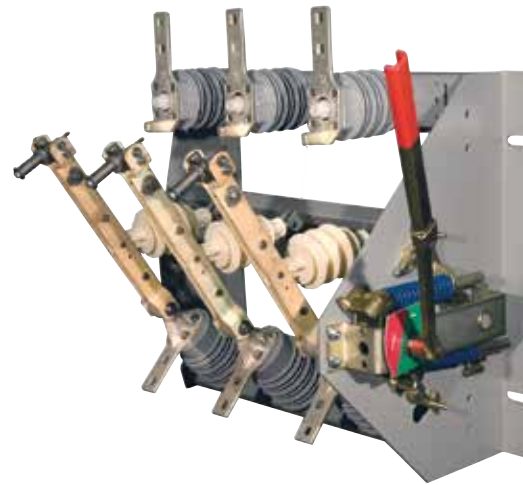

15-kV Auto-jet® II Switch

## Illustration of Auto-jet® II Switch Interrupter

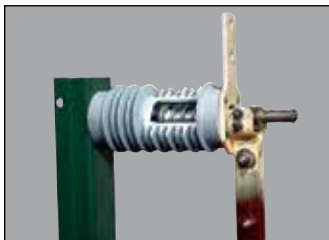

Switch closed with opening spring relaxed. Latch engaged to hold switch in position.

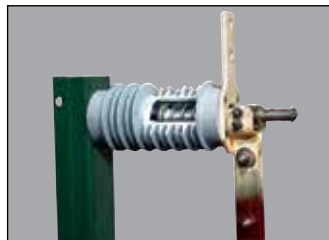

Switch closed with opening spring charged by manual operating handle.

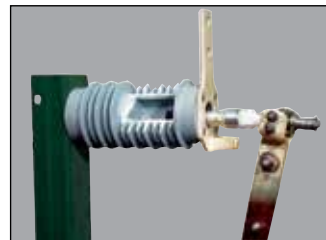

Main contacts parted, puffer and arcing springs charged.

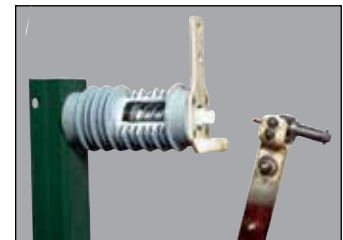

Switch open with latch engaged to hold switch in position.

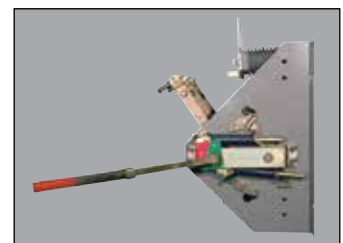
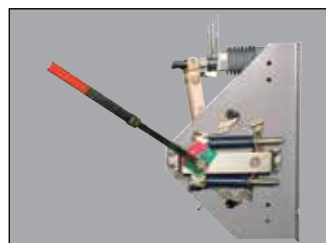
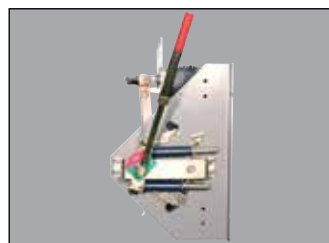

# Auto-jet® II Loadbreak Fuse Mountings

## Auto-jet® for SM-4 Refill Unit

Shown with SML-4Z Fuseholders

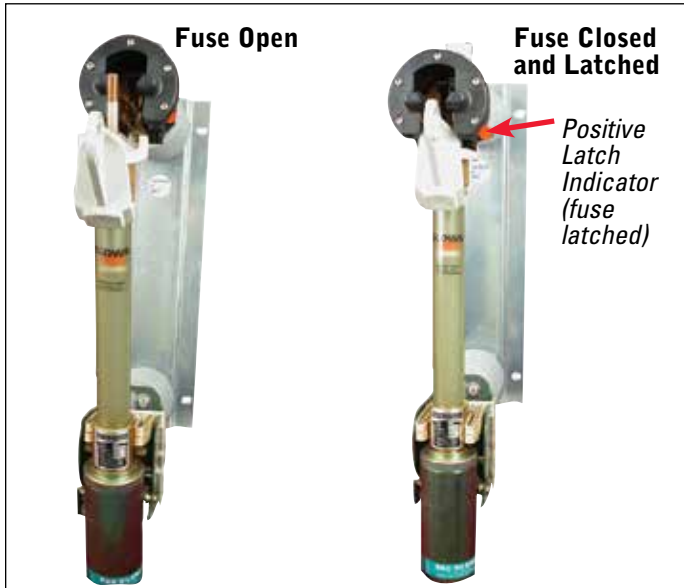

## Auto-jet® for DBU, CMU or SMU-20 Fuse Unit

Shown with DBU Fuse Assemblies

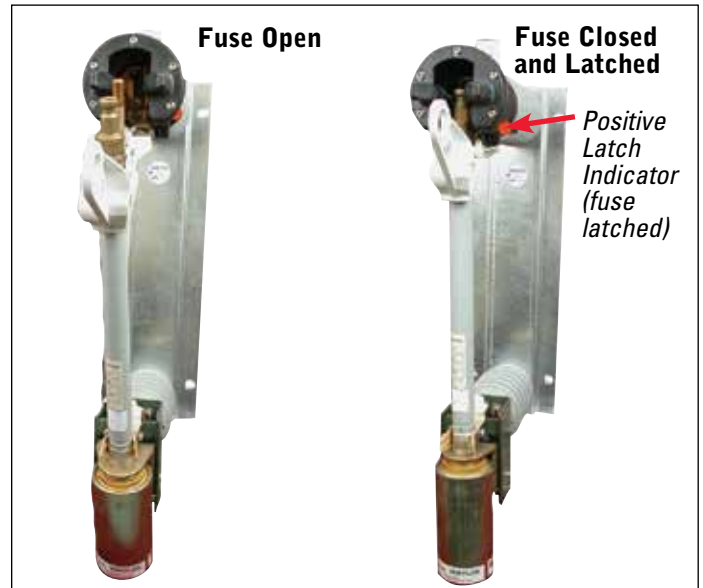

Shown here are only two of the many fuses which can be used with the Auto-jet® fuse mountings. See pages 11 and 13 for a more complete listing of fuses compatible with Auto-jet® fuse mountings.

The wide selection of fuse models available in PSI/II Pad-Mounted Switchgear provides maximum flexibility in the design and protection of underground distribution systems. Load-break Auto-jet® fuse mountings accommodate S&C Types SM-4 and SMU-20,

Eaton Type DBU, and Cooper Type CMU, NX and X-Limiter fuses in 15kV and 25kV class PSI/II units.

The Positive-Latch Indicator (PLI) on Federal Pacific load-break fuse mountings is a reliable innovative semaphore target that shows when fuse assemblies are fully closed and latched, ready for a subsequent load-break opening operation.

## Illustration of Auto-jet® EZ-Latch Fuse Interrupter

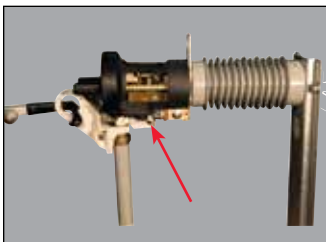

*Closed: Hookstick ready to open, latch properly engaged. See Positive Latch Indicator in photos at top of page.*

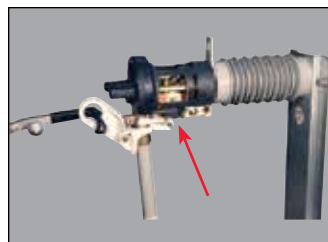

*Main contacts parted, puffer spring charged, latch disengaged.*



*Interrupter parted (internal).*

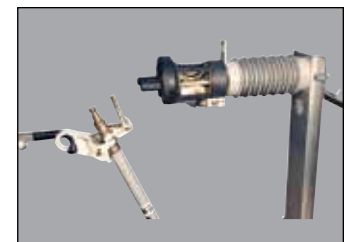

*Holder parted, Auto-jet® reset for next operation.*

The Auto-jet® fuse mounting has a direct drive, integral load-break interrupter that permits single-pole live switching in single-phase or three-phase circuits by the use of an ordinary hotstick. The Auto-jet interrupter has a 3-time fault-close duty-cycle when the fuse is closed briskly without hesitation. The overall unit rating may be limited by the fuse rating.

The same unique laminated air-jet interrupter used in the three-pole group-operated switches is applied in the Auto-jet® load-break fuse mountings.

# 15kV Basic Units-Three-Phase

14.4kV Nominal • 17kV Maximum Design • 95 kV BIL  
Circuit Diagrams with Compartment Numbers

PSI/II Pad-mounted Switchgear is designed for use only by qualified personnel trained to operate medium voltage (2.4kV - 34.5kV) switchgear. Users other than electric utilities are urged to use key interlocking devices as applicable. Should non-utility users elect not to use key interlocks, they must submit written certification that only qualified and trained personnel will operate the equipment, and that key interlock systems are not required.

Models PSI/II-4 and PSI/II-15 are only available to electric utilities.

All units are 51" high without base spacers. Do not use any dimensions for construction purposes.

To determine complete catalog number for PSI/II models with fuse compartments substitute for "X" shown as last figure in the catalog number listed below each diagram on this page the number shown in the following table:

1	S&C Type SM-4	3	Not applicable
2	S&C Type SMU-20	5	Cooper (M-E) Type NX
2	Eaton DBU	7	Cooper (CT) X-Limiter
2	Cooper Type CMU		

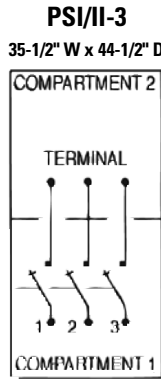

**Cat. No. 42100**

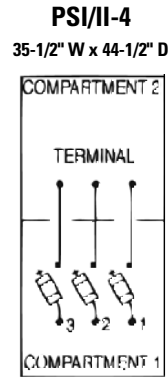

**Cat. No. 4201\***

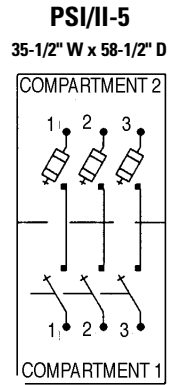

**Cat. No. 4211\***

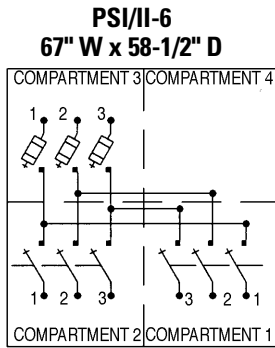

**Cat. No. 4321\***

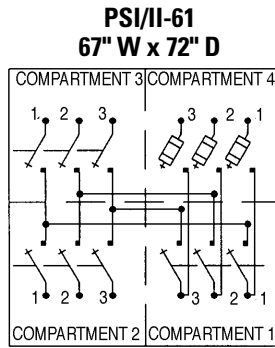

**Cat. No. 4431\***

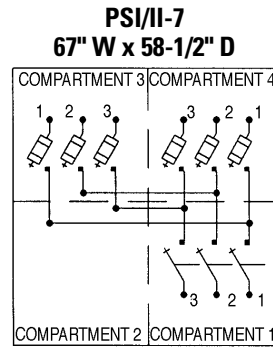

**Cat. No. 4312\***

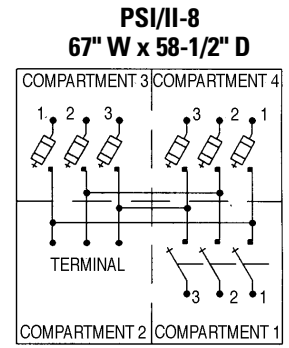

**Cat. No. 4412\***

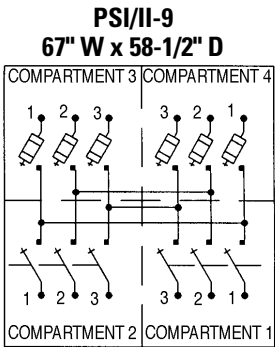

**Cat. No. 4422\***

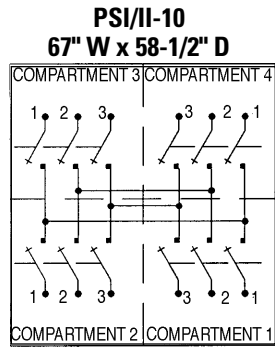

**Cat. No. 44400**

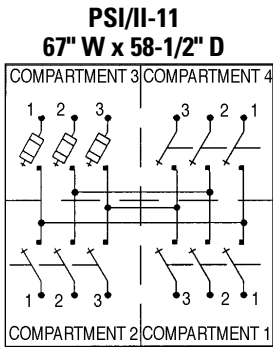

**Cat. No. 4431\***

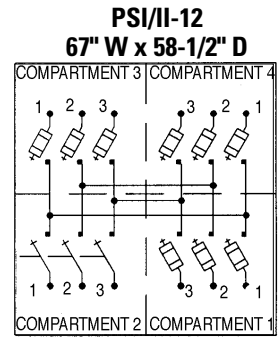

**Cat. No. 4413\***

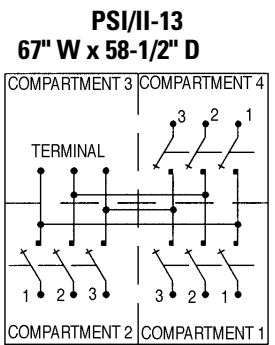

**Cat. No. 44300**

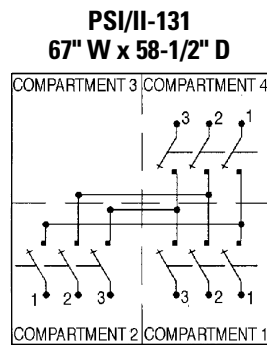

**Cat. No. 43300**

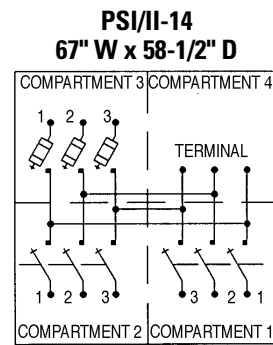

**Cat. No. 4421\***

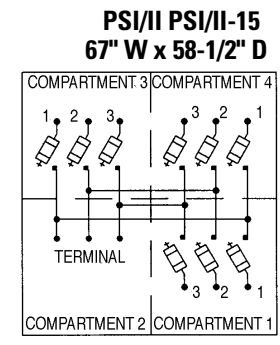

**Cat. No. 4403\***

# Current Ratings - 15kV Basic Units

## 15kV Basic Units Switch Only Units, PSI/II -3, -10, -13, -131

Auto-jet® II Switch Ratings - Amps RMS				
Continuous Current	Load and Loop Switching	Short-Circuit Withstand Current (Sym.)	3-Time Fault-Close (Asym.) <sup>①</sup>	Peak Withstand Current
600*	600	14,000	22,400	36,400
		25,000	40,000	65,000
1200	1200*	25,000	40,000	65,000

① Three-time fault rating. The Auto-jet® II switch can be closed into a fault of the magnitude specified three times and remain operable, and able to carry and to interrupt the rated current. Exceeds C37.74 rating requirements.

\*UL® Listed equipment is available for 600A switchgear at both 14kA sym/22.4kA asym and 25kA sym/40kA asym.

## Fuse Only & Switch/Fuse Units: PSI/II -4, -5, -6, -61, -7, -8, -9, -11, -12, -14, -15

Fuse Manufacturer and Type <sup>① ②</sup>	Unit Overall Ratings Amperes RMS Short Circuit <sup>③</sup>		Fuse Ratings Amperes RMS			
	Momentary ASYM	MVA 3-Phase at 14.4 kV SYM	Max.	Loadbreak <sup>④</sup>	Interrupting SYM <sup>⑤</sup>	3-Time Fault-Close <sup>⑥</sup> ASYM
S&C SM-4	20,000	310	200	200	12,500	20,000
S&C SMU-20	22,400	350	200	200	14,000	22,400
S&C SM-5 <sup>⑦ ⑧</sup>	CONTACT FACTORY					
Eaton DBU	22,400	350	200	200	14,000	22,400
Cooper CMU <sup>③</sup>	22,400	350	200	200	14,000	22,400
Cooper (M-E) NX	40,000	620	①	④	50,000	40,000
Cooper (CT) X-Limiter	40,000	620	①	④	50,000	40,000

① For fuse application and ordering information, refer to the applicable fuse manufacturer literature.

② **SM-4** fused units require three S&C Cat. No. 92352 SML-4Z fuseholders and three S&C SM-4 fuse refills per fuse compartment.

**SMU-20** fused units require three FP-3097 fuse-unit end fittings and any three of one of the following fuse units: S&C SMU-20, Eaton DBU or Cooper CMU, per fuse compartment.

**DBU** fused units require three FP-3097 fuse-unit end fittings and any three of one of the following fuse units: S&C SMU-20, Eaton DBU or Cooper CMU, per fuse compartment.

**CMU** fused units require three FP-3097 fuse-unit end fittings and any three of one of the following fuse units: S&C SMU-20, Eaton DBU or Cooper CMU, per fuse compartment.

**NX** fused units require three sets of Auto-jet® II end fittings (see table below) and three appropriately rated fuses per fuse compartment.

**NOTE:** NX Clip Style non-loadbreak fuse mountings are available and will accommodate up to 200 ampere NX fuses.

**X-Limiter** fused units require three sets of Auto-jet® II end fittings (see table below) and three appropriately rated fuses per fuse compartment. X-Limiter end fittings suitable for installation of complete fuse assemblies in SML-20 Power Fuse Mountings are also available. Consult factory for availability.

Fuse kV	Fuse Amperes	Mtg. Code	End Fittings Catalog No.
8.3	6 - 40	4	0021-2-03058#
8.3	50 - 140	5	0021-2-03056
15.5	6 - 40	5	0021-2-03056

# Includes a code 5 to code 4 adapter

- ③ Unit overall ratings are limited to the lowest component rating.
- ④ Load-break rating same as maximum continuous current rating.
- ⑤ Ratings expressed in RMS amperes asymmetrical are 1.6 times the symmetrical values listed.
- ⑥ Three-time fault-close rating: The Auto-jet® II fuse mounting can withstand a fuseholder or fuse with end fitting being closed into a fault of the magnitude specified three times when closed briskly without hesitation and remain operable and able to carry and interrupt the rated continuous current. The fuse must be replaced following a fault-closing. Refer to S&C instruction manual for SML-4Z holder and SML-20 end fitting maintenance required after each fault-close or fault interruption.
- ⑦ Contact the factory for SM-5 applications.
- ⑧ These fuses are not available in UL® Listed models.

# 25kV Basic Units-Three-Phase

25kV Nominal • 29kV Maximum Design • 125 kV BIL  
Circuit Diagrams with Compartment Numbers

PSI/II Pad-mounted Switchgear is designed for use only by qualified personnel trained to operate medium voltage (2.4kV - 34.5kV) switchgear. Users other than electric utilities are urged to use key interlocking devices as applicable. Should non-utility users elect not to use key interlocks, they must submit written certification that only qualified and trained personnel will operate the equipment, and that key interlock systems are not required.

Models PSI/II-4 and PSI/II-15 are only available to electric utilities.

All units are 61" high without base spacers. Do not use any dimensions for construction purposes.

To determine complete catalog number for PSI/II models with fuse compartments substitute for "\*" shown as last figure in catalog number listed below each diagram on this page the number shown in the following table:

1	S&C Type SM-4	3	Not applicable
2	S&C Type SMU-20	5	Cooper (M-E) Type NX
2	Eaton DBU	7	Cooper (CT) X-Limiter
2	Cooper Type CMU		

**PSI/II-3**  
43" W x 54-1/2" D

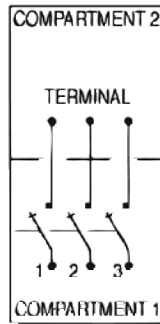

**Cat. No. 52100**

**PSI/II-4**  
43" W x 54-1/2" D

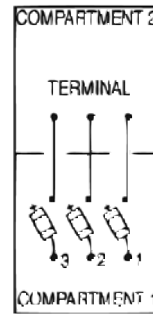

**Cat. No. 5201\***

**PSI/II-5**  
43" W x 74-1/2" D

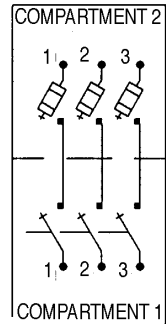

**Cat. No. 5211\***

**PSI/II-6**

82" W x 74-1/2" D

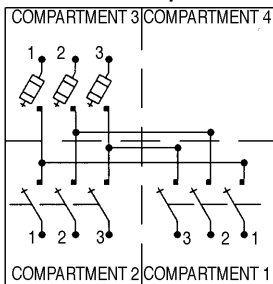

**Cat. No. 5321\***

**PSI/II-61**

82" W x 90" D

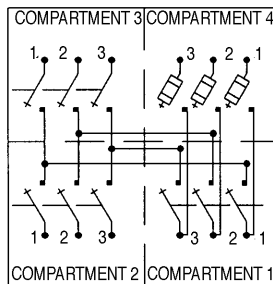

**Cat. No. 5431\***

**PSI/II-7**

82" W x 74-1/2" D

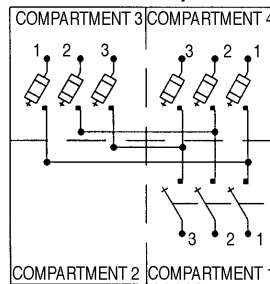

**Cat. No. 5312\***

**PSI/II-8**

82" W x 74-1/2" D

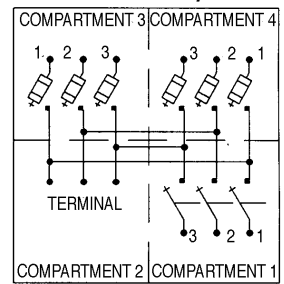

**Cat. No. 5412\***

**PSI/II-9**

82" W x 74-1/2" D

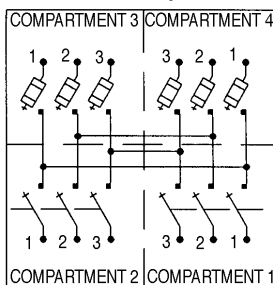

**Cat. No. 5422\***

**PSI/II-10**

82" W x 74-1/2" D

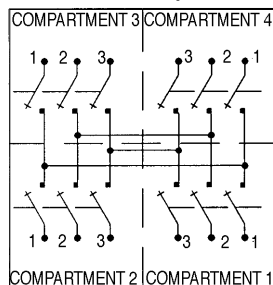

**Cat. No. 54400**

**PSI/II-11**

82" W x 74-1/2" D

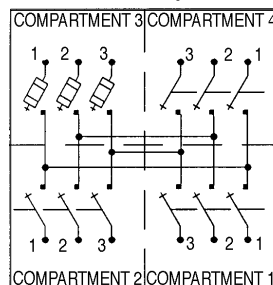

**Cat. No. 5431\***

**PSI/II-12**

82" W x 74-1/2" D

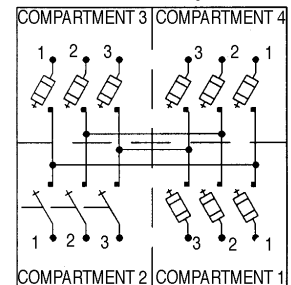

**Cat. No. 5413\***

**PSI/II-13**

82" W x 74-1/2" D

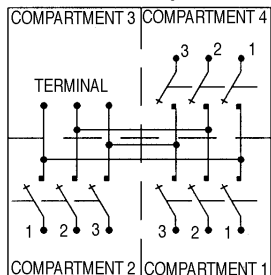

**Cat. No. 54300**

**PSI/II-131**

82" W x 74-1/2" D

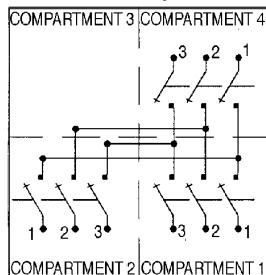

**Cat. No. 53300**

**PSI/II-14**

82" W x 74-1/2" D

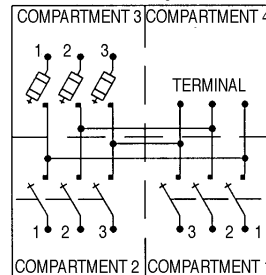

**Cat. No. 5421\***

**PSI/II-15**

82" W x 74-1/2" D

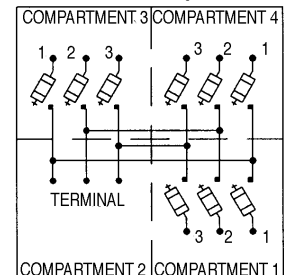

**Cat. No. 2763\***



# Current Ratings - 25kV Basic Units

## 25kV Basic Units Switch Only Units, PSI/II -3, -10, -13, -131

Auto-jet® II Switch Ratings - Amps RMS				
Continuous Current	Load and Loop Switching	Short-Circuit Withstand Current (Sym.)	3-Time Fault-Close (Asym.)	Peak Withstand Current
600	600	12,500	20,000	32,500
		25,000*	40,000*	65,000

\*UL® Listed equipment is available at 25kA sym./40kA asym.

## Fuse Only & Switch/Fuse Units: PSI/II -4, -5, -6, -61, -7, -8, -9, -11, -12, -14, -15

Fuse Manufacturer and Type ① ②	Unit Overall Ratings Amperes RMS Short Circuit ③		Fuse Ratings Amperes RMS			
	Momentary ASYM	MVA 3-Phase at 14.4 kV SYM	Max.	Loadbreak	Interrupting SYM ⑤	3-Time Fault-Close ⑥ ASYM
S&C SM-4†	20,000	540	200	200	12,500	20,000
S&C SMU-20	20,000	540	200	200	12,500	20,000
S&C SM-5 ⑦ ⑧	CONTACT FACTORY					
Eaton DBU	20,000	540	200	200	12,500	20,000
Cooper CMU ⑤	20,000	540	200	200	12,500	20,000
Cooper (M-E) NX	40,000	1,080	①	④	50,000	40,000
Cooper (CT) X-Limiter	40,000	1,080	①	④	50,000	40,000

† Applicable to solidly-grounded-neutral systems only with fuses connected by single-conductor, concentric-neutral type cable to a transformer or transformers. Rating is 9,400 amperes RMS symmetrical, 15,040 amperes RMS asymmetrical (405 MVA) for all other applications.

① For fuse application and ordering information, refer to the applicable fuse manufacturer literature.

② **SM-4** fused units require three S&C Cat. No. 92353 SML-4Z fuseholders and three S&C SM-4 fuse refills per fuse compartment.

**SMU-20** fused units require three FP-3097 fuse-unit end fittings and any three of one of the following fuse units: S&C SMU-20, Eaton DBU or Cooper CMU, per fuse compartment.

**DBU** fused units require three FP-3097 fuse-unit end fittings and any three of one of the following fuse units: S&C SMU-20, Eaton DBU or Cooper CMU, per fuse compartment.

**CMU** fused units require three FP-3097 fuse-unit end fittings and any three of one of the following fuse units: S&C SMU-20, Eaton DBU or Cooper CMU, per fuse compartment.

**NX** fused units require three sets of Auto-jet® II end fittings (see table below) and three appropriately rated fuses per fuse compartment.

**X-Limiter** fused units require three sets of Auto-jet® II end fittings (see table below) and three appropriately rated fuses per fuse compartment. X-Limiter end fittings suitable for installation of complete fuse assemblies in SML-20 Power Fuse Mountings are also available. Consult factory for availability.

③ Unit overall ratings are limited to the lowest component rating.

Fuse kV	Fuse Amperes	Mtg. Code	End Fittings Catalog No.
15.5	6 - 140	5	0021-2-03059#
15.5	50 - 125	6	0021-2-03055
23	6 - 40	6	0021-2-03055

# Includes a code 6 to code 5 adapter.

- ④ Load-break rating same as maximum continuous current rating.
- ⑤ Ratings expressed in RMS amperes asymmetrical are 1.6 times the symmetrical values listed.
- ⑥ Three-time fault-close rating: The Auto-jet® II fuse mounting can withstand a fuseholder or fuse with end fitting being closed into a fault of the magnitude specified three times when closed briskly without hesitation and remain operable and able to carry and interrupt the rated continuous current. The fuse must be replaced following a fault-closing. Refer to S&C instruction manual for SML-4Z holder and SML-20 end fitting maintenance required after each fault-close or fault interruption.
- ⑦ Contact the factory for SM-5 applications.
- ⑧ These fuses are not available in UL® Listed models.

# Optional Features

## BASE SPACER — MILD STEEL

Non-compartmented (Applicable to all models)

- A2 .....6" to increase cable terminating height
- A3 .....12" to increase cable terminating height
- A4 .....18" to increase cable terminating height
- A5 .....24" to increase cable terminating height

Compartmented (Applicable to all models)

- A6 .....6" to increase cable terminating height
- A7 .....12" to increase cable terminating height
- A8 .....18" to increase cable terminating height
- A9 .....24" to increase cable terminating height

## BASE SPACER — STAINLESS STEEL

Non-compartmented (Applicable to all models)

- AS2 .....6" to increase cable terminating height
- AS3 .....12" to increase cable terminating height
- AS4 .....18" to increase cable terminating height
- AS5 .....24" to increase cable terminating height

Compartmented (Applicable to all models)

- AS6 .....6" to increase cable terminating height
- AS7 .....12" to increase cable terminating height
- AS8 .....18" to increase cable terminating height
- AS9 .....24" to increase cable terminating height

## BARRIERS

### Dual-Purpose Barriers

These barriers are standard on all units. In the normal hanging position they help prevent inadvertent contact with live parts. They can be inserted into the open gap when switch or fuse is open.

- B1 Switch barriers, one for each switch. Applicable to all models except PSI/II-4 & PSI/II-15.
- B2 Fuse barriers, one for each fuse. Applicable to all models except PSI/II-3, -10, -13, & -131.

### Inner Barrier\*

- B4 Hinged insulating barrier, one for each door opening secured with recessed penta-head bolt. Meets RUS "dead-front" requirements. Applicable to all models.
- B5 Hinged insulating barrier, same barrier as B4, except hex-head security bolt. (Not RUS approved).

## FUSE STORAGE HOOKS

Hooks to hang three\* spare fuseholders or fuse units with end fittings on fuse compartment door.

- E1 Compartment 3. Applicable to PSI/II-61, -7, -8, -9, -12 & -15.
- E2 Compartment 4. Applicable to PSI/II-61 -7, -8, -9, -12 & -15.
- E3 Compartments 3 & 4. Applicable to PSI/II-7, -8, -9, -12, & -15.
- E4 Compartment 1. Applicable to PSI/II-4, -12, -15.
- E5 Compartment 2. Applicable to PSI/II-5.

\*Only two AJ-NX fuseholders can be accommodated on each fuse door. Not available with SM-5S power fuses.

\* Meets the requirements of Section 381.G of the National Electrical Safety Code and ANSI standard C2.

## FINISH COLOR & SPECIAL CABINET MATERIAL

(Applicable to all models)

- F2 ANSI 61 light gray
- F3 ANSI 70 sky gray
- F4 Exterior Only of Type 304 Stainless Steel cabinet
- F5 Coal Tar coating on lower three inches of enclosure or optional base spacer
- F6 All Type 304 Stainless Steel Cabinet and (or non-ferrous) hardware, except switch frame and all current-carrying parts
- F7 Same as F6 except with all stainless steel switch except current-carrying parts

## GROUND STUDS

These ground studs are standard in each unit. One is provided on each terminal, plus one per compartment to provide a convenient means of grounding with jumpers.

- G1 In all fuse compartments. Applicable to all models except PSI/II-3, -10, -13, & -131.
- G2 In all switch compartments. Applicable to all models except PSI/II-4, & -15.
- G3 In all bus termination compartments. Applicable to PSI/II-3, -4, -8, -13, -14 & -15.

## KEY INTERLOCKS AND SECURITY BOLTS

Name of ultimate user, installation number and location of pad-mounted switchgear required with order.

- K1 Anti-paralleling key interlocks to prevent paralleling switches in Compartments 1 & 2. Applicable to PSI/II-6, -61\*\*, -9, -10, -11, -13, -131 & -14.
- K2 Provisions to padlock switch in open or closed position. All models except PSI/II-4 & -15.
- K3 Key interlock to prevent opening fuse access door until all switches are locked open. Applicable to PSI/II-5, -6, -61†, -7, -8, -9, -11, -12 & -14.
- K4 Anti-paralleling and fuse access key interlock to prevent paralleling of switches in Compartments 1 & 2 and to prevent opening fuse access door until all switches are locked open. Applicable to PSI/II-6, -61††, -9, -11 & -14.
- H Hex-head security bolts in lieu of standard penta-head security bolts on all access doors. Applicable to all models.

\*\* Between switches in Compartments 2 & 3 on PSI/II-61.

† Between tap switch (Compartment 1) and fuse access door (Compartment 4) on PSI/II-61.

†† On PSI/II-61, anti-paralleling is between switches in compartments 2 & 3, and fuse access door (Compartment 4) is key interlocked with tap switch in Compartment 1.

# Optional Features

## DISTRIBUTION SURGE ARRESTERS ❶

Arrester Location	PSI/II Model
Compartment 1	3, 5, 7, 8
Compartment 2	4, 12, 15
Compartments 1 & 2	6, 9, 10, 11, 13, 131, 14
Compartments 2 & 3	61

❶ *Heavy-duty, polymer-housed surge arresters (without isolator) or equal, for 0-12,000 ft. elevation. Base mounted arresters are standard. For other arrester mounting styles, consult the factory.*

	Rated Voltage	MCOV ❶	Applicable Models
S1	3kV	2.55kV	15kV only
S2	6kV	5.1kV	15kV only
S3	9kV	7.65kV	15kV only
S4	10kV	8.4kV	15kV only
S5 **	12kV	10.2kV	15 & 25kV only
S6 **	15kV	12.7kV	15 & 25kV only
S7	18kV	15.3kV	25kV only
S8	21kV	17.0kV	25kV only
S9	24kV	19.5kV	25kV only
S10 **	27kV	22.0kV	25kV only
S13	Provision only for surge arresters. (Arresters not included.) Applicable to all models.		

❶ *Maximum Continuous Operating Voltage*

\*\* *These devices may extend below the base of the unit. Provide a cable pit or specify a base spacer.*

APPLICATION GUIDE Nominal System Suggested Arrester Rating		
Line-to-Line Voltage ❶	4 Wire Multi-Grounded Neutral System	Delta Ungrounded & Resonance Wye Systems Grounded
4,160	3	6
7,200	6	9
7,620	6	9
8,320	6	9, 10
12,000	9	15
12,470	9	15
13,200	9, 10	15
13,800	10, 12	15
20,780	15, 18	21
22,860	18	27
24,940	18	27

❶ *Application of specified rating may be permissible for ungrounded or resistance grounded systems where a single-phase ground may be tolerated for a period of time not to exceed the arrester's power frequency over-voltage capability.*

## CABLE AND TERMINATION ACCESSORIES

### Cable Supports (Includes cable brackets) ❶

- T3 One for each switch terminal and bus terminal accommodating #2 through 1000 kc mil conductor. Applicable to all models.
- T4 One for each fuse terminal accommodating #2 through 4/0 conductor. Applicable to all models except PSI/II-3, -10, -13, and -131.

### Terminal Adapters

- T5 Terminal adapter to accommodate two NEMA 1-hole or 2-hole connectors per terminal at each switch and bus terminal. For maximum cable size of 750 kc mil. Applicable to all models.

### Fault Indicator Provisions

- T6 Mounting provisions only. To accommodate one three-phase fault indicator in each switch compartment (in compartments 2 and 3 only on PSI/II-61). Applicable to all models except PSI/II-4 and PSI/II-15. For LED-Type fault indicators, consult factory.
- T7 Mounting provisions only with viewing window. To accommodate one three-phase fault indicator in each switch compartment (in compartments 2 and 3 only on PSI/II-61) with fault indicator viewing window on associated door. Applicable to all models except PSI/II-4 and PSI/II-15. For LED-Type fault indicators, consult factory.

## MISCELLANEOUS

- C Copper Bus (main and all termination points)
- ❶ *Cable supports extend below base of unit. Requires the use of a cable pit or specify a minimum of 12" base spacer.*



# STANDARD SPECIFICATION FOR LIVE-FRONT 15KV AND 25KV PSI/II PAD-MOUNTED SWITCHGEAR

## A. General

### 1. Product

The pad-mounted switchgear shall be PSI/II design as manufactured by Federal Pacific and shall conform to the following specification.

### 2. Assembly

The pad-mounted switchgear shall consist of a single self-supporting enclosure, containing interrupter switches and power fuses with the necessary accessory components, including sensing, controls, and control power supply, all completely factory-assembled and operationally checked.

### 3. Ratings

- a) Ratings for the integrated pad-mounted switchgear assembly shall be as designated below: (Select 15kV or 25kV sets of ratings from the tables below.

System Voltage Class			
	15kV†	25kV†	
kV, Nominal	14.4	25	
kV, Maximum Design	17.5	27§	
kV, BIL	95	125	
Main Bus Continuous, Amps	600	600	
Switch Load-Interrupting, Amps	600	600	
Switch Fuse Load-Interrupting, Amps	200	200	
Switch Short-Circuit Ratings ①②			
Amps, RMS Symmetrical	Standard	14,000	12,500
	HFC	25,000	25,000
Peak Withstand Current, Amperes	Standard	36,400	32,500
	HFC	65,000	65,000
MVA, 3-Phase Symmetrical at Rated Nominal Voltage	Standard	350	540
	HFC	620	1,080
Fault-Closing Amps, RMS, Asym., 3-Time Duty-Cycle	Standard	22,400	20,000
	HFC	40,000	40,000

① These are nominal switch ratings. Integrated pad-mounted unit may be limited by fuse ratings. Use fuse rating chart in next column to select proper short circuit ratings.

② Select one set of the ratings shown. (Standard or High Fault Current - HFC)

③ The three-time duty-cycle fault-closing rating means that the switch can be closed three times into rated fault amperes and remain operable and able to carry and interrupt its rated load current.

§Maximum design of the 27kV switch is 29kV.

†For UL® Listed units, ratings are 15.5kV, 14,000 or 25,000 amperes rms symmetrical, 350 MVA, 22,400 or 40,000 amperes fault closing; and 27kV, 25,000 amperes rms symmetrical, 1080 MVA, 40,000 amperes asymmetrical fault closing.

- b) The momentary and three-time duty-cycle fault-closing ratings of switches, momentary rating of bus, interrupting ratings of fuses with integral load-interrupters shall equal or exceed the short-circuit ratings of the pad-mounted switchgear.

### 4. Certification of Ratings:

The manufacturer shall be completely and solely responsible for the performance of the basic switch and load-interruption components as well as the complete integrated assembly as rated.

Fuse Ratings						
Fuse Manufacturer	Fuse Type	Three-Phase MVA Sym	Amps RMS Asym	3-Time Fault-Close Asym ①	Cont. Amps	Load-Break Amps ①
<b>14.4 kV Nominal Voltage</b>						
S&C ③	SM-4	310	20000	20000	200	200
S&C	SMU-20	350	22400	22400	200	200
S&C ②	SM-5†	—	—	—	—	—
Eaton	DBU	350	22400	22400	200	200
Cooper (M-E)	NX	620	40000	40000	100*	100
Cooper (CT)	X-Limiter	620	40000	40000	140	140
Cooper ④	CMU	350	22400	22400	200	200
<b>25 kV Nominal Voltage</b>						
S&C ③	SM-4†	540	20000	20000	200	200
S&C	SMU-20	540	20000	20000	200	200
S&C ②	SM-5†	—	—	—	—	—
Eaton	DBU	540	20000	20000	200	200
Cooper (M-E)	NX	1,080	40000	40000	40	40
Cooper (CT)	X-Limiter	1,080	40000	40000	40	40
Cooper ④	CMU	540	20000	20000	200	200

① When assembled with appropriate end fittings.

② Models with this fuse type are not UL® Listed.

③ Check with factory for UL® Listing status.

\* 100 amp @ 13.5 kV max or 80 amp @ 15 kV.

† Applicable to solidly-grounded-neutral systems only with fuses connected by a single conductor concentric neutral type cable to a transformer or transformers. Rating is 9,400 amperes RMS symmetrical, 15,000 amperes RMS asymmetrical (405 MVA symmetrical) for all other applications.

‡ Please contact factory for SM-5 applications.

The manufacturer shall furnish, upon request, certification of ratings of the basic switch components and/or the integrated pad-mounted switchgear assembly consisting of the switch and fuse components in combination with the enclosure.

### 5. Compliance with Standards and Codes

The pad-mounted switchgear shall conform to or exceed the applicable requirements of the following standards and codes:

- All portions of ANSI C57.12.28, covering enclosure integrity for pad-mounted equipment.
- Article 490.21(E) "Load Interrupters" in the National Electrical Code, which specifies that the interrupter switches in combination with power fuses shall safely withstand the effects of closing, carrying, and interrupting all possible currents up to the assigned maximum short-circuit rating.
- All portions of IEEE C37.74 covering design and testing of the distribution switchgear, components and ways.
- All portions of ANSI, IEEE, and NEMA standards applicable to the basic switch and fuse components.

The following optional feature may be specified:

- e) The pad-mounted switchgear shall be UL® Listed.

## 6. Enclosure Design

- a) To ensure a completely coordinated design, the pad-mounted switchgear shall be constructed in accordance with the minimum construction specifications of the fuse and/or switch manufacturer to provide adequate electrical clearances and adequate space for fuse handling.
- b) In establishing the requirements for the enclosure design, consideration shall be given to all relevant factors such as controlled access, tamper resistance, ventilation and corrosion resistance.

the nut per bolt. As an alternate, bolted aluminum-to-aluminum connections shall be made with a suitable equivalent surface area, i.e. 1-bolt and spring washer. Bolts shall be tightened to an appropriate foot-pounds torque.

- d) Before installation of the bus, all electrical contact surfaces shall first be prepared by abrading to remove any aluminum-oxide film. Immediately after this operation, the electrical contact surfaces shall be coated with a uniform coating of an oxide inhibitor and sealant.

## 3. Ground-Connection Pads

- a) A ground-connection pad shall be provided in each compartment of the pad-mounted gear.
- b) The ground-connection pad shall be constructed of 1/4" thick stainless steel, which shall be welded to the enclosure, and shall have a short-circuit rating equal to that of the pad-mounted gear.

## B. Construction - Assembly

### 1. Insulators

The interrupter-switch and fuse-mounting insulators shall be of a cycloaliphatic epoxy resin system with characteristics and restrictions as follows:

- a) Operating experience of at least 20 years under similar conditions.
- b) Ablative action to ensure non-tracking properties.
- c) Adequate leakage distance established by test per IEC Standard 60507.
- d) Adequate strength for short-circuit stress established by test.
- e) Conformance with applicable ANSI and IEEE standards.
- f) Homogeneity of the cycloaliphatic epoxy resin throughout each insulator to provide maximum resistance to power arcs. Ablation due to high temperatures from power arcs shall continuously expose more material of the same composition and properties so that no change in mechanical or electrical characteristics takes place because of arc-induced ablation. Furthermore, any surface damage to insulators during installation or maintenance of the pad-mounted gear shall expose material of the same composition and properties so that insulators with minor surface damage need not be replaced.
- g) Each insulator shall be x-rayed to assure it is void free. An alternate testing method may be used only by approval of the engineer.

### 2. High-Voltage Bus

- a) Bus and interconnections shall consist of bare aluminum bar with an oxide-inhibiting agent at all bus joints.
- b) Bus and interconnections shall withstand the stresses associated with short-circuit currents up through the maximum rating of the pad-mounted gear.
- c) Bolted aluminum-to-aluminum connections shall be made with a suitable number of 1/2" - 13 bolts and with two Belleville spring washers per bolt, one under the bolt head and one under the nut or with a wide, flange-head carriage bolt and one Belleville spring washer under

## C. Construction - Enclosure and Finish

### 1. Enclosure

- a) The pad-mounted gear enclosure shall be of unitized monocoque (not structural-frame-and-bolted-sheet) construction to maximize strength, minimize weight, and inhibit corrosion.
- b) The basic material for the enclosure, roof and doors shall be 11-gauge hot-rolled, pickled-and-oiled steel sheet.
- c) All structural joints and butt joints shall be welded, and the external seams shall be ground flush and smooth. Bolted structural joints are not permitted.
- d) To guard against unauthorized or inadvertent entry, enclosure construction shall not utilize any externally accessible hardware.
- e) The base shall consist of continuous 90-degree flanges, turned inward and welded at the corners, for bolting to the concrete pad.
- f) The door openings shall have 90-degree flanges, facing outward, that shall provide strength and rigidity as well as deep overlapping between doors and door openings to guard against water entry.
- g) Three resilient material cushions shall be placed on door-opening edges to prevent metal-to-metal contact that would damage finish and lead to premature corrosion.
- h) Enclosure top side edges shall overlap with roof side edges and form an internal maze to create an interface which shall allow ventilation of high-voltage compartments to help keep the enclosure interior dry while discouraging tampering or insertion of foreign objects.
- i) A heavy coat of insulating "no-drip" compound shall be applied to the inside surface of the roof to minimize condensation of moisture thereon.
- j) Insulating interphase and end barriers of NEMA GP0-3 grade fiberglass-reinforced polyester shall be provided for each interrupter switch and each set of fuses where required to achieve BIL ratings.

- k) Full-length steel barriers shall separate side-by-side compartments and barriers of the same material shall separate the front compartments from the rear compartments.
  - l) Lifting tabs shall be removable and sockets for the lifting-tab bolts shall be blind-tapped. A resilient material shall be placed between the lifting tabs and the enclosure to help prevent corrosion by protecting the finish against scratching by the tabs. To further preclude corrosion, this material shall be an open mesh to prevent moisture from being absorbed and held between the tabs and the enclosure in the event that lifting tabs are not removed.
  - m) A closed-cell gasketing material shall be placed on the bottom flange as a protective interface between the steel enclosure and the mounting pad.
  - n) Interrupter switches shall be provided with dual-purpose front barriers. These barriers, in their normal hanging positions, shall guard against inadvertent contact with live parts. It shall also be possible to lift these barriers out and insert them (but only for a temporary time interval not to exceed one week) into the open gap when the switch is open. A window panel shall be provided to allow viewing of the switch position without removing the barriers. These barriers shall meet the requirements of Section 381G of the National Electrical Safety Code (ANSI Standard C2).
  - o) Each fuse shall be provided with a dual-purpose front barrier. These barriers, in their normal hanging positions, shall guard against inadvertent contact with live parts. It shall also be possible to lift these barriers out and insert them (but only for a temporary time interval not to exceed one week) into the open gaps when the fuses are in the disconnect position. These barriers shall meet the requirements of Section 381G of the National Electrical Safety Code (ANSI Standard C2).
  - p) To prevent moisture ingress, the roof shall be one-piece construction and shall not include any gasketed joints or any unground weld butt joints exposed to the exterior.
2. Doors
- a) Doors shall be constructed of 11-gauge hot-rolled, pickled-and-oiled steel sheet.
  - b) Doors providing access to high voltage shall have door-edge flanges that shall overlap with door-opening flanges and shall be formed to create an interface that shall guard against water entry and discourage tampering or insertion of foreign objects, but shall allow ventilation to help keep the enclosure interior dry.
  - c) Doors providing access to high voltage shall have a minimum of three hinges. Door hinges shall be of stainless steel with stainless steel hinge pins to provide strength, security, and corrosion resistance. Mounting hardware shall be stainless steel or zinc-nickel-plated steel, and shall not be externally accessible to guard against tampering.
  - d) In consideration of controlled access and tamper resistance, each set of double doors providing access to high voltage shall be equipped with an automatic three-point latching mechanism.
- 1) The latching mechanism shall be spring loaded, and shall latch automatically when the door is closed. All latch points shall latch at the same time to preclude partial latching.
  - 2) A penta-head socket wrench or tool shall be required to actuate the mechanism to unlatch the door and, in the same motion, recharge the spring for the next closing operation.
  - 3) The latching mechanism shall have provisions for padlocking that incorporate a means to protect the padlock shackle from tampering and that shall be coordinated with the latches.
    - i) It shall not be possible to access the penta-head actuator until the padlock is removed.
    - ii) It shall not be possible to unlatch the mechanism until the padlock is removed.
    - iii) It shall not be possible to insert the padlock until the mechanism is completely latched closed.
  - f) Doors providing access to solid-material power fuses shall have provisions to store spare fuse units or refill units.
  - g) Each door shall be provided with a door holder of stainless steel located above the door opening. The holder shall be hidden from view when the door is closed, and it shall not be possible for the holder to swing inside the enclosure.
3. Finish
- a) Full coverage at joints and blind areas shall be achieved by processing enclosures independently of components such as doors and roofs before assembly into the unitized structures.
  - b) All exterior seams shall be sanded or ground smooth for neat appearance.
  - c) All surfaces shall undergo a chemical cleaning, phosphatizing or zirconization and sealing process before any protective coatings are applied in order to remove oils and dirt, form a chemically and anodically neutral conversion coating, improve the finish-to-metal bond, and retard underfilm propagation of corrosion.
  - d) The finishing system shall be applied without sags or runs for a pleasing appearance.
  - e) After the enclosure is completely assembled and the components (switches, bus, etc.) are installed, the finish shall be inspected for scuffs and scratches.
  - f) Blemishes shall be carefully touched up by hand to restore the protective integrity of the finish.
  - g) Unless otherwise specified, the color shall be Munsell No. 7GY3.29/1.5, dark green.
  - h) To assure that the finishing system is capable of resisting corrosion, the manufacturer shall provide on request, certification that representative test panels, protected by the manufacturer's finish system, have passed the coating system performance criteria in section 5.5 of ANSI C57.12.28 as verified by an independent third party certifier, such as UL®.

## D. Basic Components

### 1. Interrupter Switches

- a) Interrupter switches shall have a three-time duty-cycle fault-closing rating equal to or exceeding the short-circuit rating of the pad-mounted gear. These ratings define the ability to close the interrupter switch three times against a three-phase fault with asymmetrical current in at least one phase equal to the rated value, with the switch remaining operable and able to carry and interrupt rated current. Tests substantiating these ratings shall be performed at maximum voltage with current applied for at least 10 cycles. Certified test abstracts establishing such ratings shall be furnished upon request.
- b) Interrupter switches shall be operated by means of stored-energy operators installed by the switch manufacturer.
- c) Each interrupter switch shall be completely assembled and adjusted by the switch manufacturer on a single rigid mounting frame. The frame shall be of welded steel construction such that the frame intercepts the leakage path which parallels the open gap of the interrupter switch to positively isolate the load circuit when the interrupter switch is in the open position.
- d) Interrupter switches shall be provided with a single-arm blade construction with parallel current paths for each phase for circuit closing including fault-closing, continuous current carrying, and circuit interrupting. Spring-loaded auxiliary blades that can become out of sequence with a main blade shall not be permitted.
- e) Interrupter switch blade supports shall be permanently fixed in place in a unified hinge contact assembly utilizing a louvered contact configuration that provides expansion and, therefore, increased pressure at the contact transfer point for a stable interface during momentary currents.
- f) Switch-blade hinge contacts that have wiping contacts directly connected to switch terminals and can be pulled apart by cable connected to the switch terminals are specifically prohibited, such designs can present potential arcing faults if cables are pulled.
- g) Circuit interruption shall be accomplished by use of an interrupter which is positively and inherently sequenced with the blade position. It shall not be possible for the blade and interrupter to get out of sequence. Circuit interruption shall take place completely within the interrupter, with essentially no external arc or flame.
- h) To increase contact separation speed, interrupter switch contacts on both sides of the arcing area shall be spring assisted to reduce arcing time and to rapidly increase the dielectric gap.
- i) To further insure arc extinction, air shall be compressed and simultaneously injected into the arcing area to cool the arc and thereby not rely solely on blade travel to insure arc extinction.
- j) Arc extinction shall not rely on gases generated by ablative action of the arc playing on any interrupter switch components or materials which will carbonize, deplete or otherwise erode such components and materials.

- k) Ground studs shall be provided at all switch terminals. Ground studs shall also be provided on the ground pad in each interrupter switch compartment. The momentary rating of the ground studs shall equal or exceed the short-circuit ratings of the pad-mounted gear.

### The following optional features may be specified:

- l) Bracket-mounted distribution-class surge arresters, metal-oxide type (specify rating), shall be provided at all source switch terminals.
- m) Switch terminals shall be provided with adapters to accommodate two cables per phase.
- n) Mounting provisions shall be provided to accommodate one three-phase fault indicator with three single-phase sensors in each interrupter switch compartment and (with or without, select one) a viewing window in the door.
- o) Mounting provisions to accommodate LED-Type fault indicators. Holes for such fault indicators shall be plugged with a tamper-resistant arrangement for shipment.

### 2. Fuses

- a) Fuses shall be solid-material power fuses or current-limiting fuses as specified by the equipment purchaser.
- b) Fuse-mounting jaw contacts shall incorporate an integral load-interrupter that shall comply with all the preferred and optional test requirements in IEEE C37.74 to permit live switching of fuses with a hookstick equipped with a grapples tool and shall have a 3-time duty-cycle fault-closing capability at the interrupting rating of 22,400 amperes symmetrical.
  - 1) The integral load-interrupter housing shall be of the same cycloaliphatic epoxy resin as the insulators.
  - 2) The integral load-interrupter shall be in the current path continuously only during circuit interruption. Auxiliary blades or linkages shall not be used.
  - 3) Live switching shall be accomplished by a firm, steady opening pull on the fuse pull ring with a hookstick. No separate load-interrupting tool shall be required.
  - 4) The integral load-interrupter shall require a hard pull to unlatch the fuse to reduce the possibility of an incomplete opening operation.
  - 5) Internal moving contacts of the integral load-interrupter shall be self-resetting after each opening operation to permit any subsequent closing operation to be performed immediately.
  - 6) Circuit interruption shall take place completely within the integral load-interrupter with essentially no external arc or flame.
  - 7) The integral load-interrupter and the fuse shall be provided with separate fault-closing contacts and current-carrying contacts. The fuse hinge shall be self-guiding and, together with the fault-closing contacts, shall guide the fuse into the current-carrying contacts during closing operations. Circuit-closing inrush currents and fault currents shall be picked up by the fault-closing contacts, not by the current-carrying contacts or interrupting contacts.



- 8) Integral load-interrupters for fuses shall have a three-time duty-cycle fault-closing capability equal to the interrupting rating of the fuse at the applicable voltage (14.4kV or 25kV). The duty-cycle fault-closing capability defines the level of available fault-current into which the fuse can be closed the three-times without a quick-make mechanism and when operated vigorously through its full travel without hesitation at any point, with the integral load-interrupter remaining operable and able to carry and interrupt currents up to the emergency peak-load capabilities of the fuse.
  - 9) To increase contact separation speed, integral load-interrupter contacts on the source side of the arcing area shall be spring assisted to retract and, thereby, reduce arcing time and to rapidly increase the dielectric gap.
  - 10) To further insure arc extinction, air shall be compressed and simultaneously injected into the arcing area to cool the arc and thereby not rely solely on blade travel to insure arc extinction.
  - 11) Arc extinction shall not rely on gases generated by ablative action of the arc playing on any interrupter switch components or materials which will carbonize, deplete or otherwise erode such components and materials.
- c) Fuse terminal pads shall be provided with a two-position adapter, making it possible to accommodate a variety of cable-terminating devices.
  - d) Ground studs shall be provided at all fuse terminals. One ground stud shall also be provided on the ground pad in each fuse compartment. The momentary rating of the ground studs shall equal or exceed the short-circuit ratings of the pad-mounted gear.
  - e) Fuse-mounting interrupter housing shall be provided with a target that protrudes and becomes visible only after the fuse has become fully latched, secured, closed and ready for opening.
  - f) Fuse-mounting interrupter housing shall incorporate a mechanical latching arrangement that shall capture the fuse contact rod on closing. On opening, the latching arrangement shall not release until after the circuit has been interrupted. The mechanical latching arrangement shall make certain that the fuse-contact rod does not rely solely on friction to keep the contacts engaged and to avoid premature contact separation during the circuit interrupting sequence.
- d) Both sides of each barrier providing access to a fuse shall be provided with a sign indicating that "Fuses May Be Energized in Any Position".
  - e) Any barriers used to guard against access to energized live parts shall be provided with a "Danger" sign on both sides.
  - f) Dual-purpose barriers shall be provided with a label indicating that such barriers shall not be left inserted into the open gap for more than one week.
  - g) Doors to fuse compartments shall include a label illustrating the correct latched condition for the integral load interrupter.
  - h) Doors to fuse compartments shall include a label illustrating correct opening/closing switching operation for fuses with integral load interrupters.
  - i) Removable barriers shall include a label stating that barrier should not be removed when the equipment is energized.

## 2. Nameplate, Ratings Labels, & Connection Diagrams

- a) The outside of both the front and back shall be provided with nameplates indicating the manufacturer's name, catalog number, model number, and date of manufacture.
- b) The inside of each door shall be provided with a ratings label indicating the following: voltage ratings; main bus continuous rating; short-circuit ratings (amperes, RMS symmetrical and MVA three-phase symmetrical at rated nominal voltage); the type of fuse and its ratings including duty-cycle fault-closing capability; and interrupter switch ratings, including duty-cycle fault-closing capability and amperes, short-time, (momentary, amperes rms asymmetrical and one-second, amperes rms symmetrical).
- c) A three-line connection diagram showing interrupter switches, fuses and bus along with the manufacturer's model number shall be provided on the inside of both the front and rear doors, and on the inside of each switch operating hub access cover.

## F. Accessories

1. Furnish fuse components of the type specified by the purchaser. No fuse units shall be supplied unless actually noted by the purchaser in the specifications available to the switchgear manufacturer at the time of quotation.
2. A fuse handling tool as recommended by the fuse manufacturer shall be furnished if noted by the purchaser in the specifications.

## E. Labeling

### 1. Hazard-Alerting Signs & Labels

- a) All external doors providing access to high voltage shall be provided with suitable hazard-alerting signs.
- b) The inside of each door providing access to high voltage shall be provided with a "Danger—High Voltage — Keep Out — Qualified Persons Only" sign.
- c) Each barrier providing access to an interrupter switch shall be provided with a sign indicating that "Switch Blades May Be Energized in Any Position" on both sides.

