

REVISIONS			
REV.	DESCRIPTION	DATE	APPROVED
REL-01		10/2/2006	

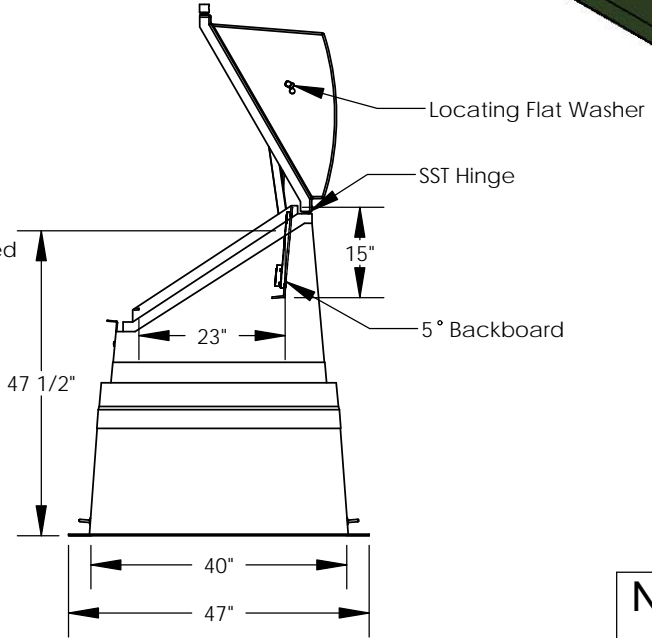
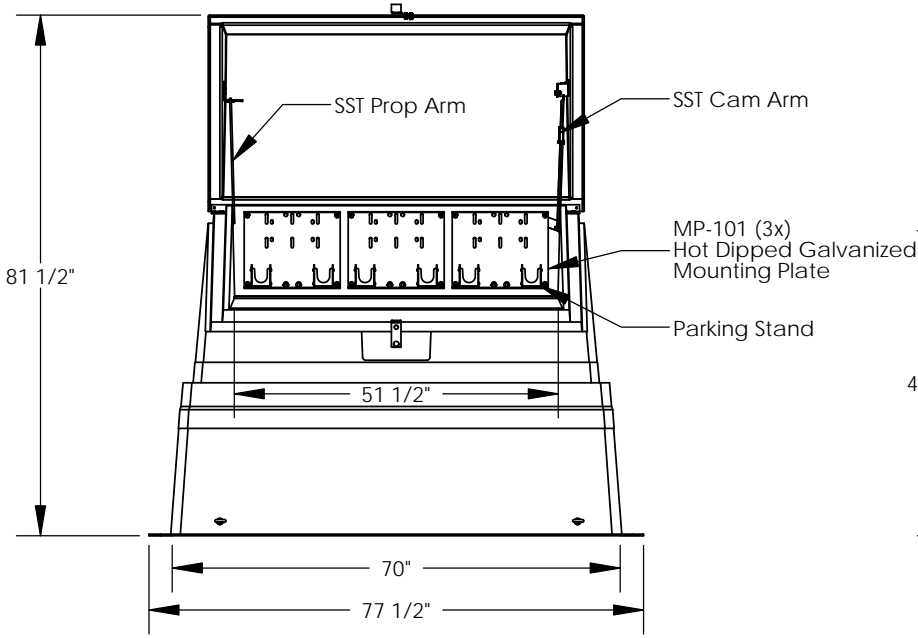
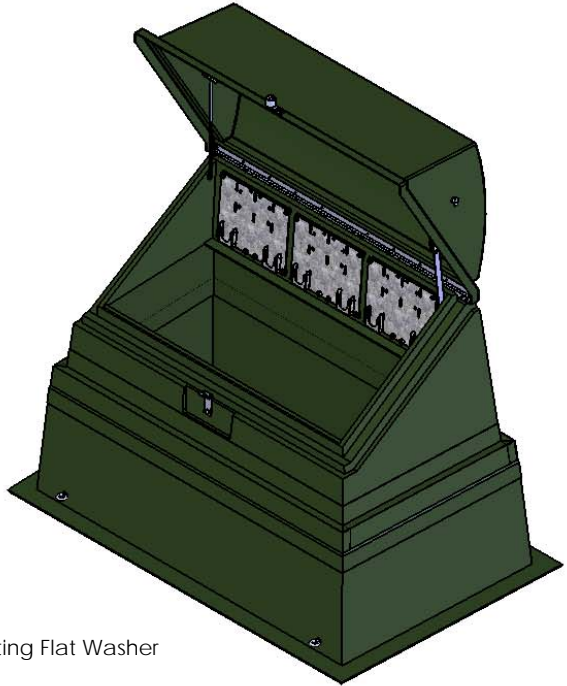
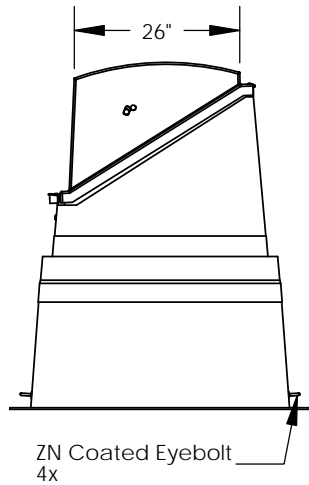
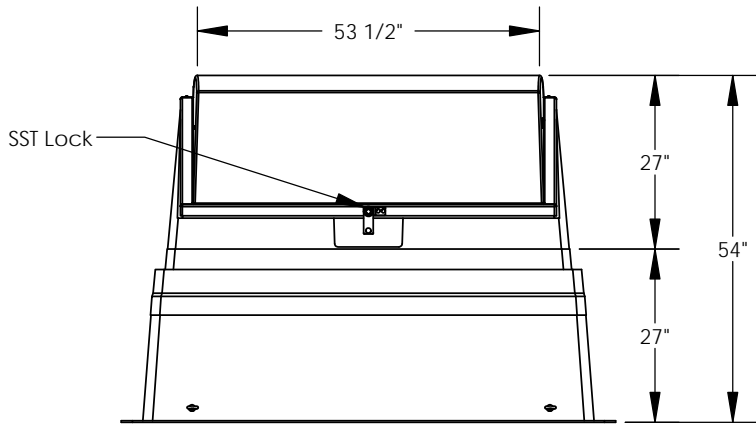

**Nordic Fiberglass, Inc.**

21415 US Hwy 75 NW, Warren, MN 56762  
www.nordicfiberglass.com  
218-745-5095 ph. --- 218-745-4990 fax

ND-360-MG-101-X-X

**PROPRIETARY AND CONFIDENTIAL**  
THE INFORMATION CONTAINED IN THIS DRAWING IS THE SOLE PROPERTY OF NORDIC FIBERGLASS, INC. ANY REPRODUCTION IN PART OR AS A WHOLE WITHOUT THE WRITTEN PERMISSION OF NORDIC FIBERGLASS, INC. IS PROHIBITED.

Customer Name: N/A		
DIMENSIONS ARE IN INCHES TOLERANCES: ANGLES ± 1° FRACTIONAL ± 1/2 ONE PLACE DECIMAL ±.060 TWO PLACE DECIMAL ±.030 THREE PLACE DECIMAL ±.015		
MATERIAL		
DRAWN	P.J.W.	10/02/06
CHECKED	---	--/--/--

SIZE	ITEM ID:	REV.
<b>A</b>	02880.00	<b>REL-01</b>
SCALE:1:30		SHEET 1 OF 1