

REVISIONS			
REV.	DESCRIPTION	DATE	APPROVED
REL-01		7/3/2007	

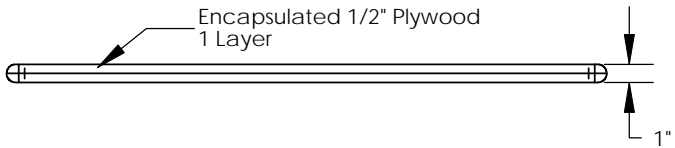
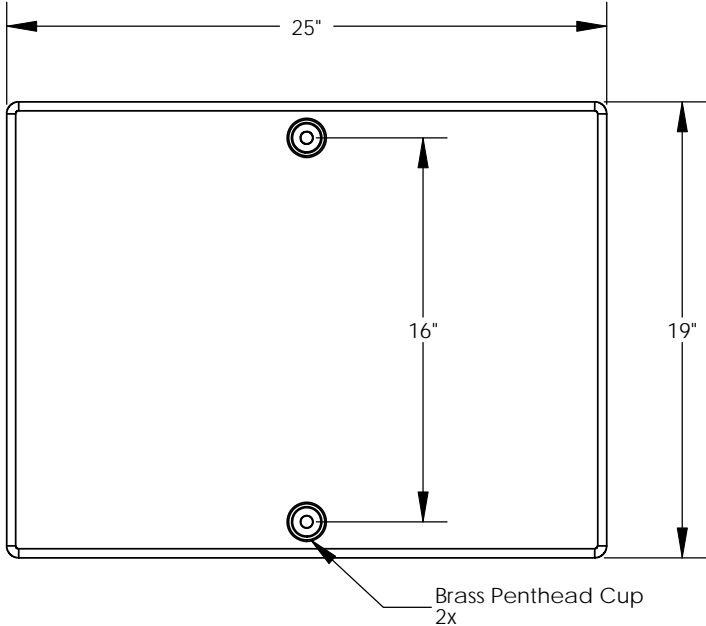
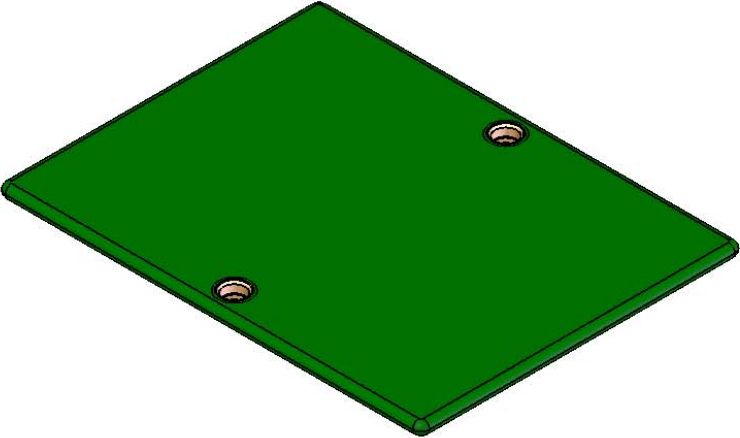

NOTE:
Includes (2) 3/8x1.5 SST Pentahead Bolts

Nordic Fiberglass, Inc.
21415 US Hwy 75 NW, Warren, MN 56762
www.nordicfiberglass.com
218-745-5095 ph. --- 218-745-4990 fax

GSC-25-19-MG

PROPRIETARY AND CONFIDENTIAL
THE INFORMATION CONTAINED IN THIS DRAWING IS THE SOLE PROPERTY OF NORDIC FIBERGLASS, INC. ANY REPRODUCTION IN PART OR AS A WHOLE WITHOUT THE WRITTEN PERMISSION OF NORDIC FIBERGLASS, INC. IS PROHIBITED.

Customer Name: N/A		
DIMENSIONS ARE IN INCHES		
TOLERANCES: ANGLES $\pm 1^\circ$		
FRACTIONAL $\pm 1/2$		
ONE PLACE DECIMAL $\pm .060$		
TWO PLACE DECIMAL $\pm .030$		
THREE PLACE DECIMAL $\pm .015$		
MATERIAL		
	NAME	DATE
DRAWN	P.J.W.	07/03/07
CHECKED	---	--/--/--

SIZE	ITEM ID:	REV.
A	02090.00	REL-01
SCALE:1:8	SHEET 1 OF 1	