

REVISIONS			
REV.	DESCRIPTION	DATE	APPROVED
REL-01		5/2/2007	
REL-02	Changed from 2 Layers 1/2" Plywood and 2x4's	1/15/2008	P.J.W.
REL-03	Added 1 2x6	8/22/2012	M.F.K.

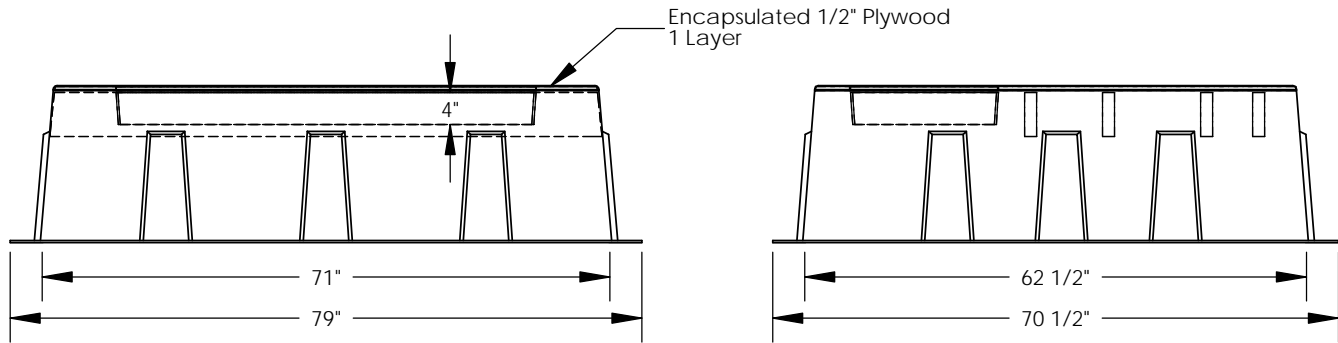
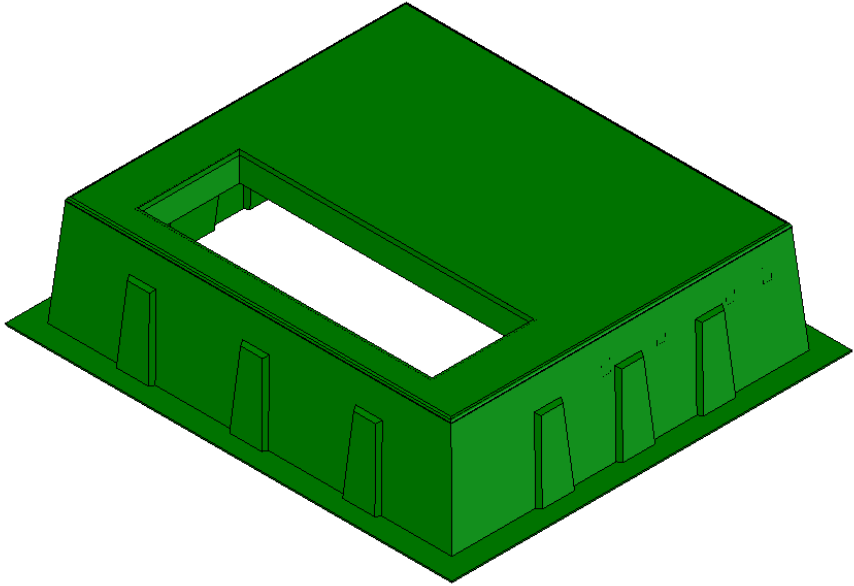
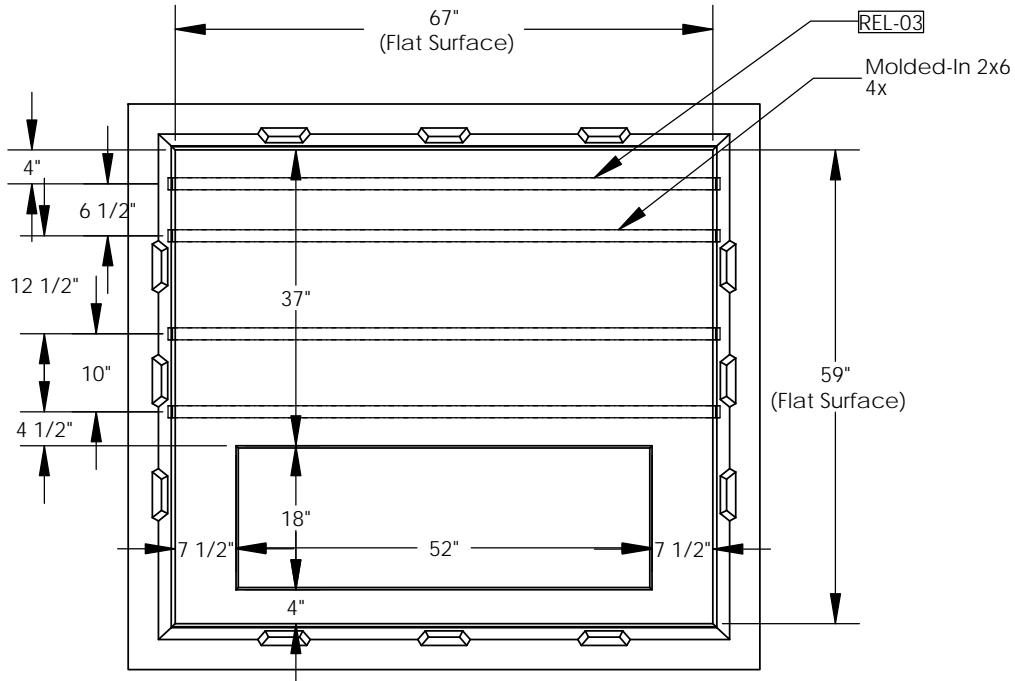

**PROPRIETARY AND CONFIDENTIAL**  
 THE INFORMATION CONTAINED IN THIS DRAWING IS THE SOLE PROPERTY OF NORDIC FIBERGLASS, INC. ANY REPRODUCTION IN PART OR AS A WHOLE WITHOUT THE WRITTEN PERMISSION OF NORDIC FIBERGLASS, INC. IS PROHIBITED.

Customer Name: N/A		
DIMENSIONS ARE IN INCHES		
TOLERANCES: ANGLES ± 1°		
FRACTIONAL ± 1/32		
ONE PLACE DECIMAL ±.060		
TWO PLACE DECIMAL ±.030		
THREE PLACE DECIMAL ±.015		
MATERIAL		
DRAWN	NAME	DATE
	P.J.W.	05/02/07
CHECKED		--/--

**Nordic Fiberglass, Inc.**  
 21415 US Hwy 75 NW, Warren, MN 56762  
 www.nordicfiberglass.com  
 218-745-5095 ph. --- 218-745-4990 fax

GS-67-59-18RT-MG-52x18		
SIZE	ITEM ID:	REV.
<b>A</b>	01510.00	<b>REL-03</b>
SCALE:1:24	SHEET 1 OF 1	