

REVISIONS			
REV.	DESCRIPTION	DATE	APPROVED
REL-01		5/15/2007	

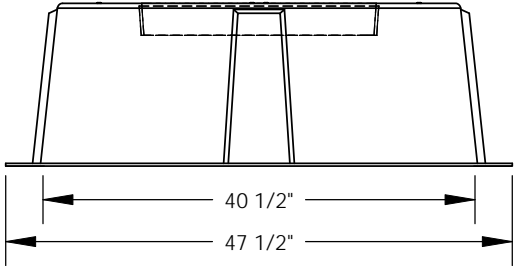
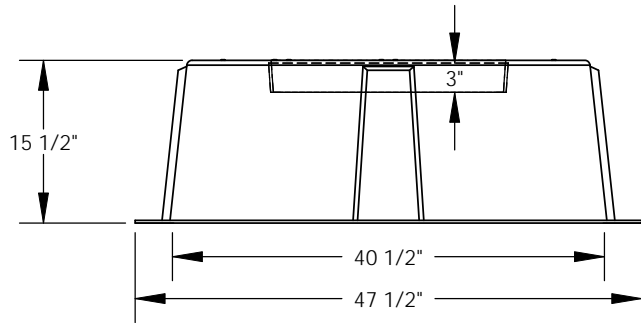
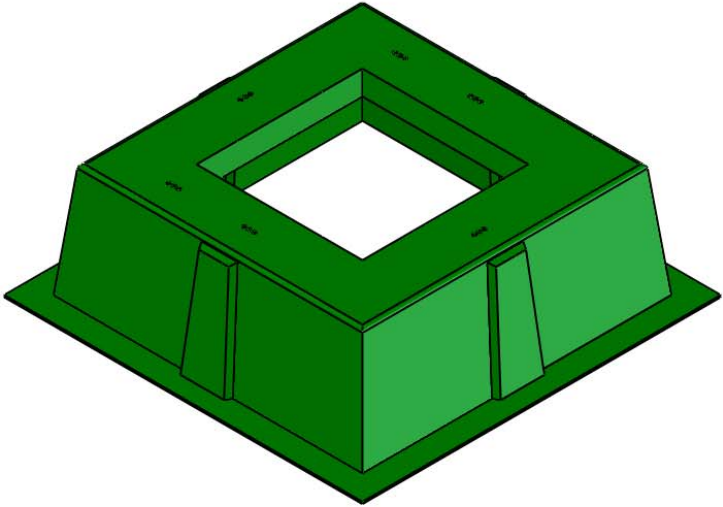
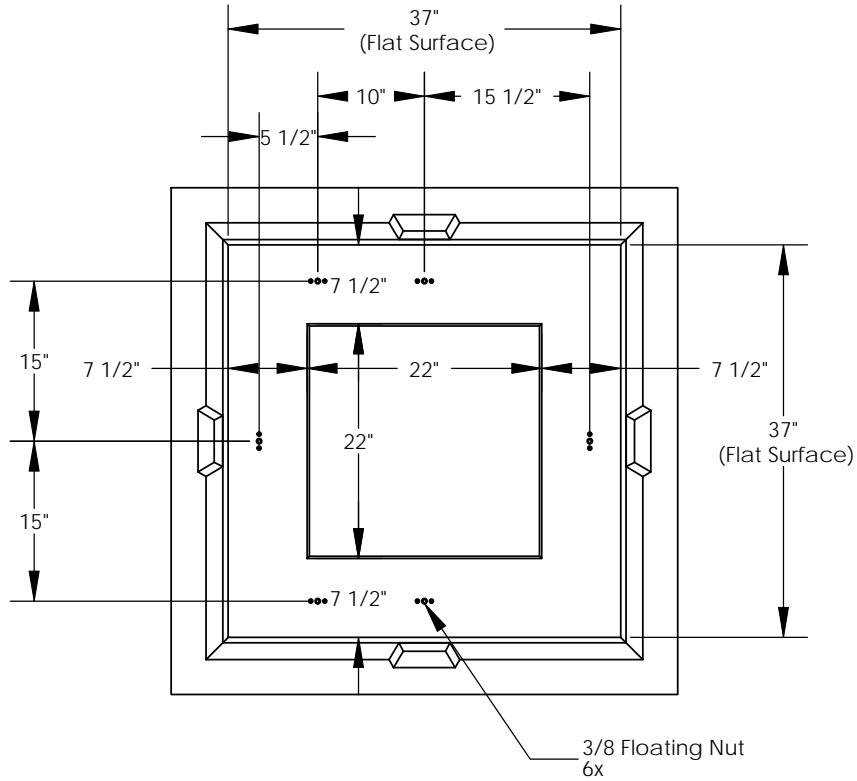

PROPRIETARY AND CONFIDENTIAL
 THE INFORMATION CONTAINED IN THIS DRAWING IS THE SOLE PROPERTY OF NORDIC FIBERGLASS, INC. ANY REPRODUCTION IN PART OR AS A WHOLE WITHOUT THE WRITTEN PERMISSION OF NORDIC FIBERGLASS, INC. IS PROHIBITED.

Customer Name: N/A		
DIMENSIONS ARE IN INCHES		
TOLERANCES: ANGLES $\pm 1^\circ$		
FRACTIONAL $\pm 1/32$		
ONE PLACE DECIMAL $\pm .060$		
TWO PLACE DECIMAL $\pm .030$		
THREE PLACE DECIMAL $\pm .015$		
MATERIAL	NAME	DATE
DRAWN	P.J.W.	05/15/07
CHECKED	---	--/--/--

Nordic Fiberglass, Inc.		
21415 US Hwy 75 NW, Warren, MN 56762		
www.nordicfiberglass.com		
218-745-5095 ph. --- 218-745-4990 fax		
GS-36-36-15-MG-22x22		
SIZE	ITEM ID:	REV.
A	00740.00	REL-01
SCALE:1:18		SHEET 1 OF 1