

NORDIC FIBERGLASS, INC.
Warren, MN 56762

Ground Sleeve

DRAWN: 6/4/90

DWG. NO. GS-30-18-30:MG:21x10

SCALE: 1:12

WEIGHT:

SHEET 1 OF 1

Drawn By: M.H. 3/97

Date	Appv'd by	Description

4 1/2" 21" 4 1/2"

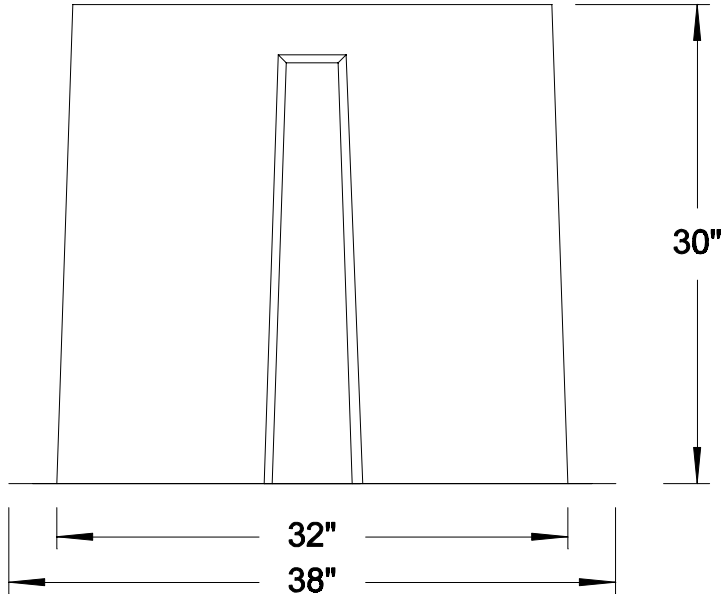

4" 10" 4"

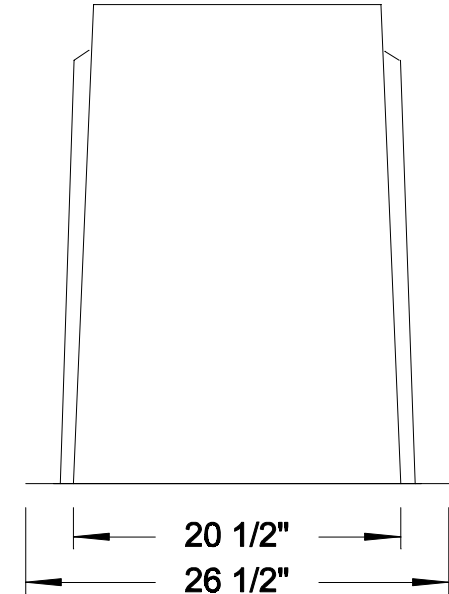

NOTICE: This document and all of the information, data, and designs thereon are the property of Nordic Fiberglass, Inc. Consent for the retention and use of this document is granted to persons other than Nordic Fiberglass, Inc. only on the conditions that the document and all of its contents will be held in strict confidence. This document is not to be reproduced in whole or in part for manufacture or procurement from sources other than Nordic Fiberglass, Inc. without the written permission of Nordic Fiberglass, Inc.