

REVISIONS			
REV.	DESCRIPTION	DATE	APPROVED
REL-01		7/5/2007	

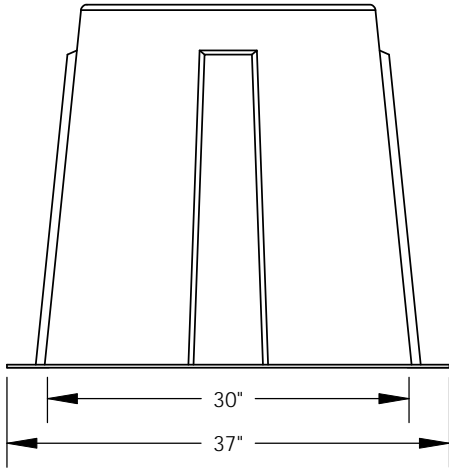
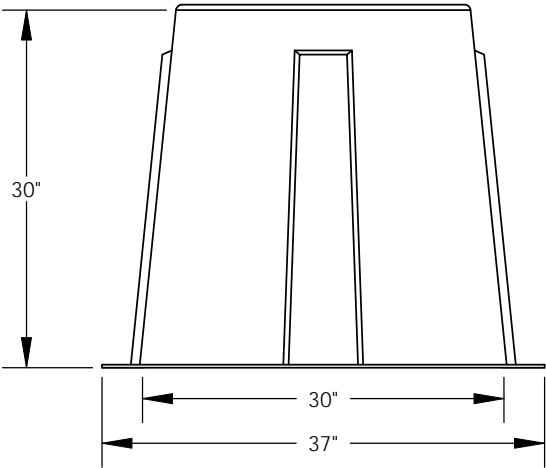
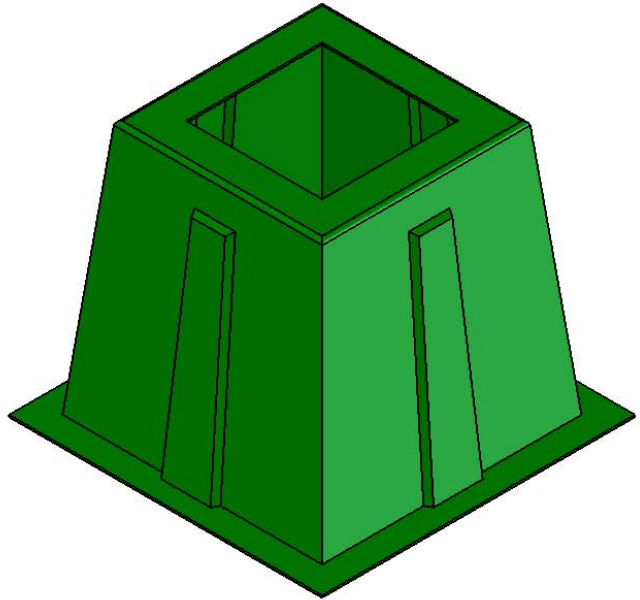
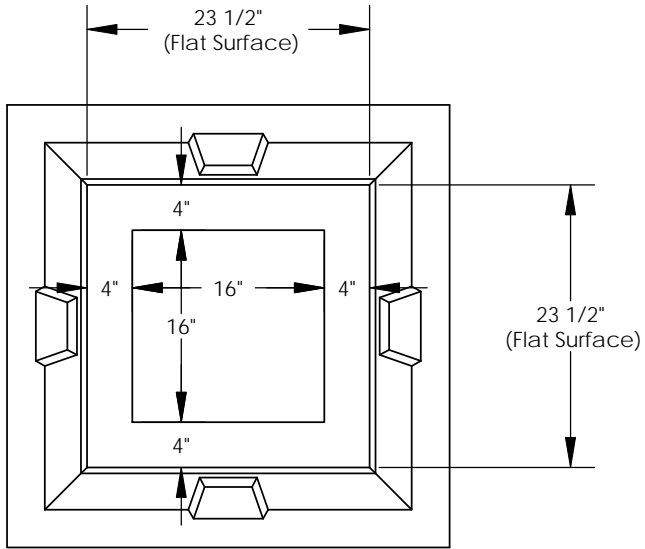

NOTE:
Includes (4) 3/8x1.5 SST Hex Bolts,
(4) 3/8 SST Hex Nuts, (8) 3/8 SST Flat
Washers, (4) 1/2 SST Flat Washers

Nordic Fiberglass, Inc.

21415 US Hwy 75 NW, Warren, MN 56762
www.nordicfiberglass.com
218-745-5095 ph. --- 218-745-4990 fax

GS-24-24-30-MG-16x16

PROPRIETARY AND CONFIDENTIAL
THE INFORMATION CONTAINED IN THIS DRAWING IS THE SOLE PROPERTY OF
NORDIC FIBERGLASS, INC. ANY REPRODUCTION IN PART OR AS A WHOLE
WITHOUT THE WRITTEN PERMISSION OF NORDIC FIBERGLASS, INC. IS PROHIBITED.

Customer Name: N/A		
DIMENSIONS ARE IN INCHES		
TOLERANCES: ANGLES ± 1°		
FRACTIONAL ± 1/2		
ONE PLACE DECIMAL ±.060		
TWO PLACE DECIMAL ±.030		
THREE PLACE DECIMAL ±.015		
MATERIAL		
DRAWN	NAME	DATE
	P.J.W.	07/05/07
CHECKED	---	--/--/--

SIZE	ITEM ID:	REV.
A	00350.00	REL-01
SCALE:1:16	SHEET 1 OF 1	