

REVISIONS			
REV.	DESCRIPTION	DATE	APPROVED
REL-01		5/7/2007	

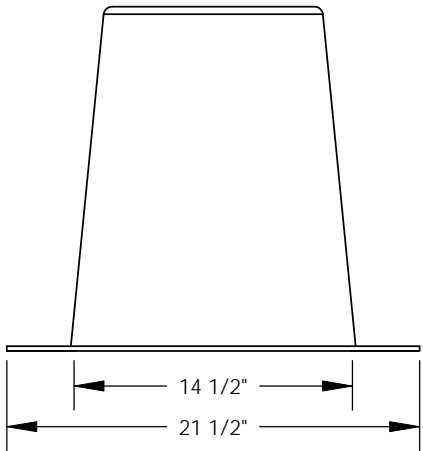
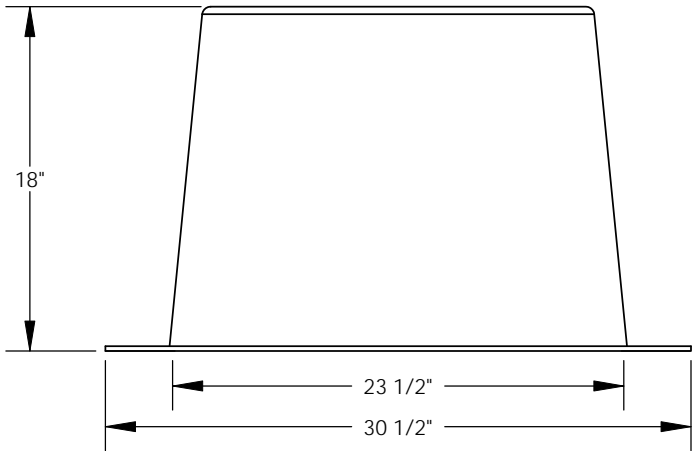
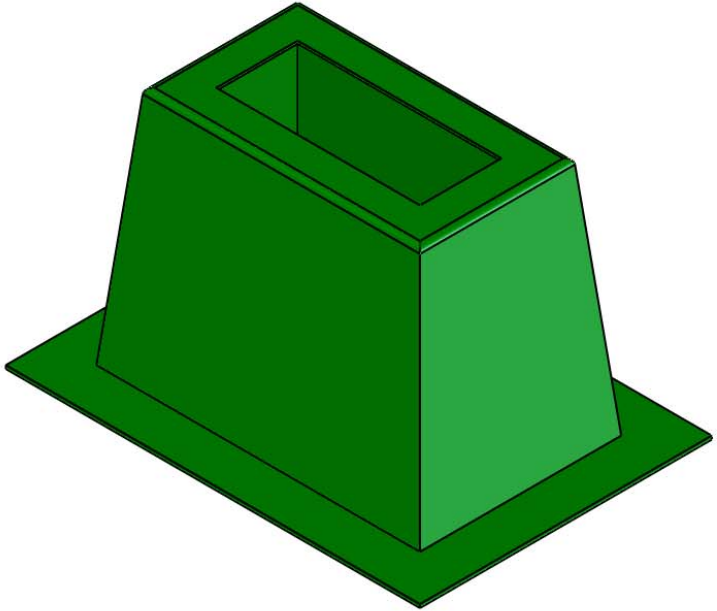
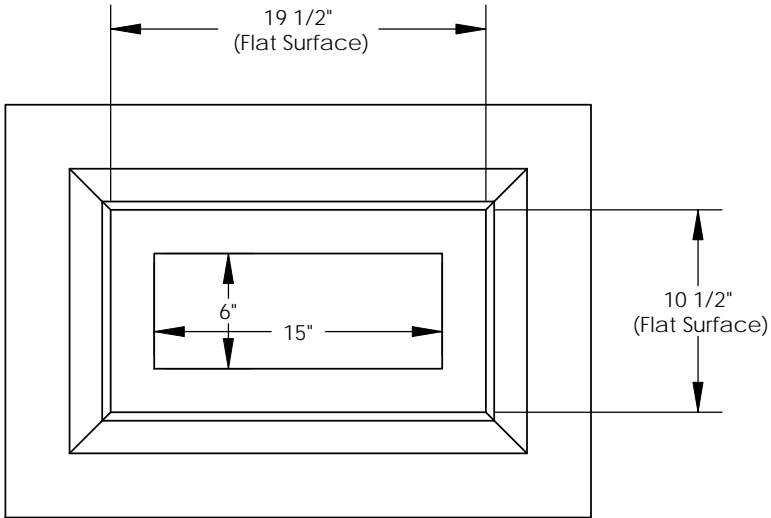

NOTE:  
Includes (4) 3/8x1.25 ZN Hex Bolts,  
(4) 3/8 ZN Hex Nuts, (8) 3/8 ZN Flat  
Washers, (4) 1/2 ZN Flat Washers

**Nordic Fiberglass, Inc.**

21415 US Hwy 75 NW, Warren, MN 56762  
www.nordicfiberglass.com  
218-745-5095 ph. --- 218-745-4990 fax

GS-19-10-18M-MG-15x6

**PROPRIETARY AND CONFIDENTIAL**  
THE INFORMATION CONTAINED IN THIS DRAWING IS THE SOLE PROPERTY OF  
NORDIC FIBERGLASS, INC. ANY REPRODUCTION IN PART OR AS A WHOLE  
WITHOUT THE WRITTEN PERMISSION OF NORDIC FIBERGLASS, INC. IS PROHIBITED.

Customer Name: N/A		
DIMENSIONS ARE IN INCHES TOLERANCES: ANGLES $\pm 1^\circ$ FRACTIONAL $\pm 1/2$ ONE PLACE DECIMAL $\pm .060$ TWO PLACE DECIMAL $\pm .030$ THREE PLACE DECIMAL $\pm .015$		
MATERIAL		
	NAME	DATE
DRAWN	P.J.W.	05/07/07
CHECKED	---	--/--/--

SIZE	ITEM ID:	REV.
<b>A</b>	00313.00	<b>REL-01</b>
SCALE: 1:10	SHEET 1 OF 1	